

# TILEBOOK

2020-2021

CATÁLOGO GERAL



## INDEX

ANARCHIC	54
ARDÓSIA	148
AVANT	120
BEDROCK	130
BETON	88
BETON HIDRÁULICO	96
BETON PATCHWORK	98
BRANCOS	232
BRICK	154
BROOKLYN	224
BURLINGTON	228
CEMENTONE	70
CODE	266
COTTO	168
DECK	48
FORM	110
FLOOR	262
GAME OF STONES	196
HERITAGE	100
LINEA	160
LINEA VINTAGE_CLASSIC	164
LIVING	74
LIVING HIDRÁULICO	82
LUXOR	230
MAPLE	40
MATRIX	116
METALLICA	182
MIX&MATCH	174
MOLEANOS	138
NEO	210
OAK	16
OXYDA	226
PAINTWOOD	30
PLASTER	222
PLAYTILE	234
RORIZ	150
RUSTY	84
SANDSTONE	140
SASSI	62
SHABBY	26
SLATE	152
STEEL	220
TERRAZZO	124
URBAN CONCRETE	66
VERMONT	6
VINTAGE	42

<b>60X120</b>	<b>60X60</b>	<b>15X60</b>			
ANARCHIC	54	ANARCHIC	54	DECK	48
BEDROCK	130	BEDROCK	130	VINTAGE	42
BETON	88	BETON	88		
GAME OF STONES	196	CEMENTONE	70	<b>30X90</b>	
LIVING	74	GAME OF STONES	196	BRANCOS	232
METALLICA	182	LIVING	74	GAME OF STONES	196
SASSI	62	MATRIX	116	METALLICA	182
TERRAZZO	124	METALLICA	182	NEO	210
		MIX&MATCH	174		
<b>20X120</b>	<b>MOLEANOS</b>	138	<b>25X70</b>		
DECK	48	RUSTY	84	BRANCOS	232
OAK	16	SANDSTONE	140	PLASTER	222
PAINTWOOD	30	SASSI	62	STEEL	220
SHABBY	26	TERRAZZO	124		
VERMONT	6	URBAN CONCRETE	66	<b>50X50</b>	
				AVANT	120
<b>20X90</b>	<b>30X60</b>				
ANARCHIC	54	ANARCHIC	54	<b>20X50</b>	
BEDROCK	130	ARDÓSIA	148	BRANCOS	232
BETON	88	BEDROCK	130	CODE	266
LIVING	74	BETON	88	PLAYTILE	234
METALLICA	182	BRANCOS	232		
SASSI	62	BROOKLYN	224	<b>40X40</b>	
TERRAZZO	124	BURLINGTON	228	BETON	88
		CEMENTONE	70	HERITAGE	100
<b>45X90</b>		DECK	48		
ANARCHIC	54	FORM	110	<b>33X33</b>	
BEDROCK	130	GAME OF STONES	196	ARDÓSIA	148
BETON	88	LIVING	74	COTTO	168
LIVING	74	LUXOR	230	FLOOR	262
METALLICA	182	MATRIX	116	LUXOR	230
SASSI	62	METALLICA	182	MATRIX	116
TERRAZZO	124	MIX&MATCH	174	RORIZ	150
		MOLEANOS	138		
<b>22.5X90</b>		NEO	210	<b>33X47</b>	
OAK	16	OXYDA	226	BRICK	154
SHABBY	26	RORIZ	150	LINEA	160
VERMONT	6	RUSTY	84	LINEA VINTAGE_CLASSIC	164
		SANDSTONE	140		
<b>15X75</b>		SASSI	62		
DECK	48	SLATE	152		
MAPLE	40	TERRAZZO	124		
OAK	16	URBAN CONCRETE	66		
PAINTWOOD	30				





### 1981

Constituição de duas empresas: a GRESART e a AZUGRÉS, a primeira vocacionada para a produção de pavimentos e segunda para revestimentos.

Establishment of the two companies: GRESART and AZUGRÉS, the first devoted to the production floor tiles and the second to wall tiles.

### 1986

Renovação da sua equipa de gestão e a fusão das duas unidades da qual resultou a GRESART, SA na sua estrutura jurídica e produtiva do presente.

Renewal of general management team and the merger of two units in "Gresart Ceramica" in its productive and legal structure up to the present time.

### 1995/1997

Reestruturação da empresa com investimento em novos equipamentos de produção, ampliação de instalações e reformulação do layout fabril. Grandes melhorias na componente ambiental através da reciclagem de águas e lamas assim como o tratamento dos efluentes gasosos.

Company reengineering and significant investment in new production equipment, facilities expansion and factory layout. Significant environmental improvements such as water recycling, sludge treatment and gas emission filtering.

### 2005

Certificação do Sistema de Garantia da Qualidade no âmbito da norma NP EN ISO 9002/1995 e posteriormente a certificação para o normativo NP EN ISO 9001:2000, que tem sido objecto de renovação e revalidação anualmente.

Certification of Quality System within the NP EN ISO 9002/1995 certification and later to the standard NP EN ISO 9001:2000, which has been subject to annual renewal and revalidation.

# 2020

## QUALITY TRADITION AND INNOVATION

### SINCE 1981

#### QUALIDADE TRADIÇÃO E INOVAÇÃO DESDE 1981

Nova unidade fabril com equipamento industrial de última geração resultando no aumento da capacidade produtiva e na oferta de produtos de grandes formatos em grés porcelânico vidrado, em pasta branca e corada com tecnologia digital.

New production facility using state of the art industrial equipment in order to achieve quantity production increase and production of large format glazed porcelain tiles in white body and coloured biscuit using digital technology.





# WE MEET LEED™ REQUIREMENTS

Ceramic Product, references of GRESART:	% recycled material included	Sources:
Floor tiles: Glazed ceramic, Glazed porcelain	20-27%	Internal quality data: internal wastes from the process
Wall tiles: White body, Monoporosa	28%	External data: external wastes

## REDUCE REDUZIR

- SELF-PRODUCTION OF CLEAN ENERGY BY SOLAR PANELS. OPTIMIZATION OF CONSUMPTION IN THE PRODUCTION PROCESS.

- POLLUTION REDUCTION THROUGH LOCAL SUPPLIERS OF RAW MATERIALS AND OTHER ELEMENTS NECESSARY FOR THE CERAMIC PRODUCTION AND MARKETING.

- MINIMUM GAS OUTPUT TO ATMOSPHERE (KYOTO PROTOCOL COMPLIANCE).

- REDUÇÃO DA POLUIÇÃO PELA PRODUÇÃO DE ENERGIA LIMPA PARA AUTO-CONSUMO ATRAVÉS DE PAINÉIS SOLARES. OTIMIZAÇÃO DO CONSUMO ENERGÉTICO NO PROCESSO PRODUTIVO.

- REDUÇÃO DA POLUIÇÃO ATRAVÉS DO USO DE ESSENCIALMENTE FORNECEDORES LOCAIS DE MATÉRIAS PRIMAS E ELEMENTOS NECESSÁRIOS À PRODUÇÃO E COMERCIALIZAÇÃO DOS PRODUTOS.

- REDUÇÃO DAS EMISSÕES DE GASES (OBSERVÂNCIA INTEGRAL DO PROTOCOLO DE KYOTO).

## REUSE REUTILIZAR

- 100% WATER RECYCLING.

- 100% CRUDE RESIDUE PRODUCTION GENERATED.

- 100% reciclagem de águas.

- 100% reutilização do resíduo bruto gerado.

## RECYCLE RECICLAR

- 100% RECYCLABLE PACKAGING.

- 100% TREATED PALLETS FOR PROTECTION OF FLORA AND FAUNA.

- 100% utilização de materiais de embalagem recicláveis.

- 100% utilização de paletes tratadas de acordo com as normas internacionais de proteção da flora e fauna.





# VERMONT

 GLAZED PORCELAIN TILES \_GRÉS PORCELÂNICO VIDRADO \_GRÈS CÉRAMÉ ÉMAILLÉ  
 FEINSTEINZEUG GLASIERT \_GRÉS PORCELÂNICO  
EN 14411:2016 GROUP \_GRUPO \_GROUPE \_GRUPPE Bl



20X120 / 8"X48"

▼  
10.5 MM  
▲



22.5X90 / 9"X36"

▼  
9 MM  
▲

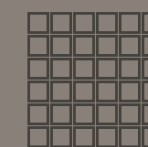

MOSAICO 4,7X4,7  
30X30

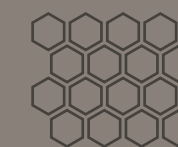

MOSAICO HEXAGONAL  
26X31,5



CHEVRON 1  
20X120

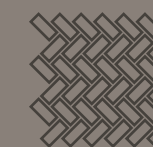

CHEVRON 2  
29,9X29,9

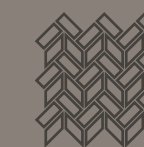

CHEVRON 3  
30X30

## USAGE \_USO

WALL, FLOOR, INTERIOR, EXTERIOR, COMMERCIAL, RESIDENTIAL



VERMONT ASH



VERMONT GREY



VERMONT CREAM



VERMONT TAUPE



VERMONT KHAKI



VERMONT BROWN





VERMONT CREAM 20X120 R





VERMONT GREY 20X120 R







# VERMONT

 **GLAZED PORCELAIN TILES** \_GRÉS PORCELÂNICO VIDRADO \_GRÈS CÉRAME ÉMAILLÉ  
 **FEINSTEINZEUG GLASIERT** \_GRÉS PORCELÂNICO  
 EN 14411:2016 GROUP \_GRUPO \_GROUPE \_GRUPPE **Bl**



VERMONT ASH  
GP 0645



VERMONT GREY  
GP 0646



VERMONT CREAM  
GP 0648



VERMONT TAUPE  
GP 0649



VERMONT KHAKI  
GP 0647



VERMONT BROWN  
GP 0650

## SURFACE \_SUPERFÍCIE

MATT

## FEATURES \_ATRIBUTOS

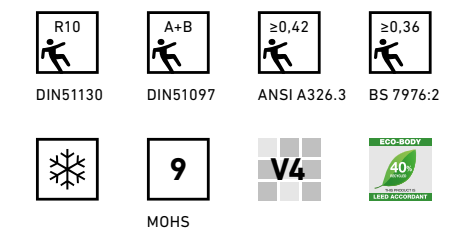

## FINISH \_ACABAMENTO

NATURAL (NAT)  
RECTIFIED (R)

## SIZES \_FORMATOS

20X120 R  
22,5X90 R  
22,5X90 NAT

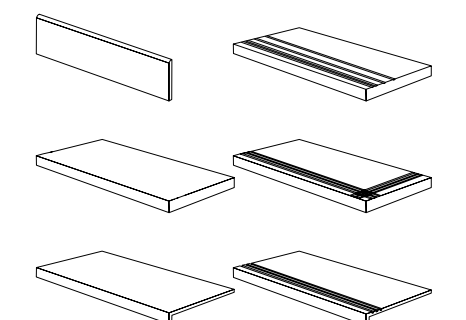

SKIRTINGS \_RODAPÉ 9,5X120

SKIRTINGS \_RODAPÉ 7X90

STEP \_DEGRAU 20X120

STEP \_DEGRAU 22,5X90

STEP \_DEGRAU TEC. 20X120

STEP \_DEGRAU TEC. 22,5X90

VERMONT ASH 20X120 R  
PLAYTILE DECOR BLUE 20X50





# OAK

 **GLAZED PORCELAIN TILES** \_GRÉS PORCELÂNICO VIDRADO \_GRÈS CÉRAME ÉMAILLÉ  
 **FEINSTEINZEUG GLASIERT** \_GRÉS PORCELÂNICO  
 EN 14411:2016 **GROUP** \_GRUPO \_GROUPE \_GRUPPE **Bl**

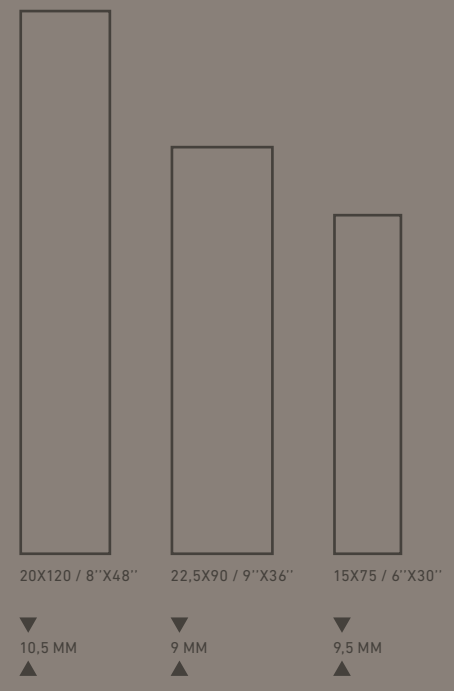

## USAGE\_USO

WALL, FLOOR, INTERIOR, EXTERIOR, COMMERCIAL, RESIDENTIAL



OAK CREAM 20X120 R  
METALLICA TITAN 60X120 SP





OAK HONEY 22,5X90

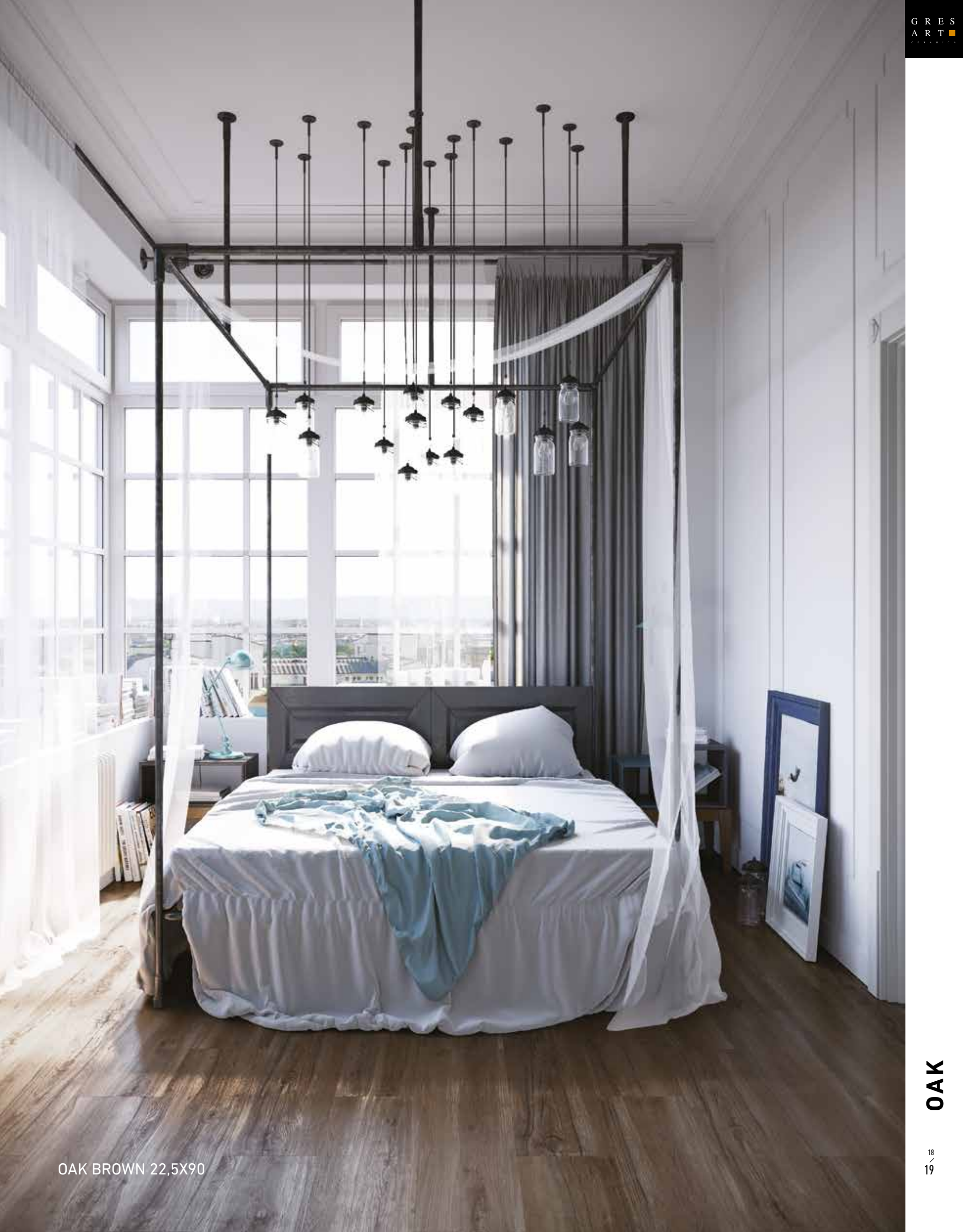

OAK BROWN 22,5X90





OAK TORTORA 20X120 R  
BRICK PARDO 33X47





OAK CREAM 20X120 R  
METALLICA TITAN 60X120 SP



# OAK

 **GLAZED PORCELAIN TILES** \_GRÉS PORCELÂNICO VIDRADO \_GRÈS CÉRAME ÉMAILLÉ  
 FEINSTEINZEUG GLASIERT \_GRÉS PORCELÂNICO  
 EN 14411:2016 GROUP \_GRUPO \_GROUPE \_GRUPPE Bl



OAK WHITE  
GP 0622



OAK TORTORA  
GP 0518



OAK TAUPE  
GP 0644



OAK DARK  
GP 0623

# OAK

 **GLAZED PORCELAIN TILES** \_GRÉS PORCELÂNICO VIDRADO \_GRÈS CÉRAME ÉMAILLÉ  
 FEINSTEINZEUG GLASIERT \_GRÉS PORCELÂNICO  
 EN 14411:2016 GROUP \_GRUPO \_GROUPE \_GRUPPE Bl



OAK BROWN  
GP 0515



OAK HONEY  
GP 0514



OAK CREAM  
GP 0517



OAK TEA  
GP 0524

## SURFACE \_SUPERFÍCIE

MATT

## FEATURES \_ATRIBUTOS

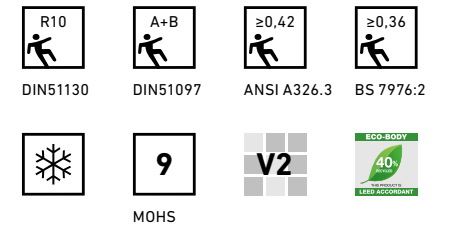

## FINISH \_ACABAMENTO

NATURAL (NAT)  
RECTIFIED (R)

## SIZES \_FORMATOS

20X120 R  
22,5X90 R  
22,5X90 NAT  
15X75 R  
15X75 NAT

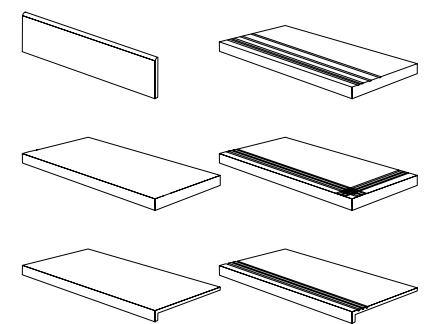

SKIRTINGS \_RODAPÉ 9,5X120  
 SKIRTINGS \_RODAPÉ 7X90  
 SKIRTINGS \_RODAPÉ 7X75  
 STEP \_DEGRAU 20X120  
 STEP \_DEGRAU 22,5X90  
 STEP \_DEGRAU TEC. 20X120  
 STEP \_DEGRAU TEC. 22,5X90





# SHABBY

 GLAZED PORCELAIN TILES \_GRÉS PORCELÂNICO VIDRADO \_GRÈS CÉRAMÉ ÉMAILLÉ  
 FEINSTEINZEUG GLASIERT \_GRÉS PORCELÁNICO  
 EN 14411:2016 GROUP \_GRUPO \_GROUPE \_GRUPPE Bla



20X120 / 8"X48"

▼ 10.5 MM

▲



22.5X90 / 9"X36"

▼ 9 MM

▲

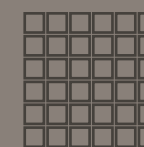

MOSAICO 4,7X4,7  
30X30

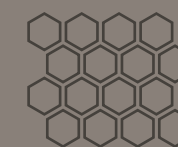

MOSAICO HEXAGONAL  
26X31,5



CHEVRON 1  
20X120

USAGE \_USO

WALL, FLOOR, INTERIOR, EXTERIOR, COMMERCIAL, RESIDENTIAL



SHABBY WHITE



SHABBY GREY



# SHABBY

 **GLAZED PORCELAIN TILES** \_GRÉS PORCELÂNICO VIDRADO \_GRÈS CÉRAME ÉMAILLÉ  
 **FEINSTEINZEUG GLASIERT** \_GRÉS PORCELÂNICO  
 EN 14411:2016 GROUP \_GRUPO \_GROUPE \_GRUPPE Bla



SHABBY WHITE  
GP 0520



SHABBY GREY  
GP 0521

## SURFACE \_SUPERFÍCIE

MATT

## FEATURES \_ATRIBUTOS

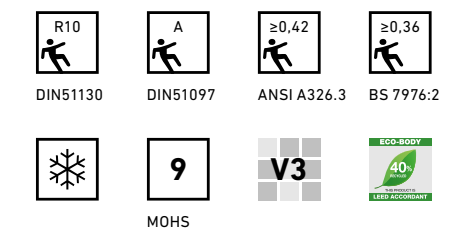

## FINISH \_ACABAMENTO

NATURAL (NAT)  
RECTIFIED (R)

## SIZES \_FORMATOS

20X120 R  
22,5X90 R  
22,5X90 NAT

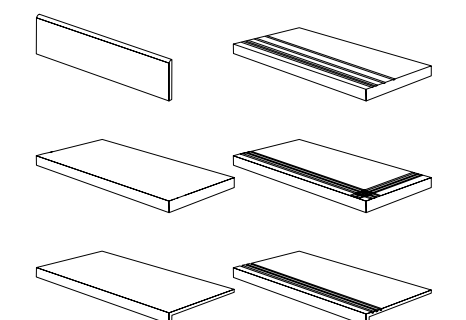

SKIRTINGS \_RODAPÉ 9,5X120

SKIRTINGS \_RODAPÉ 7X90

STEP \_DEGRAU 20X120

STEP \_DEGRAU 22,5X90

STEP \_DEGRAU TEC. 20X120

STEP \_DEGRAU TEC. 22,5X90



# PAINTWOOD

 GLAZED PORCELAIN TILES \_GRÉS PORCELÂNICO VIDRADO \_GRÈS CÉRAMÉ ÉMAILLÉ  
 FEINSTEINZEUG GLASIERT \_GRÉS PORCELÁNICO  
EN 14411:2016 GROUP \_GRUPO \_GROUPE \_GRUPPE Bla



20X120 / 8"X48"

▼  
10.5 MM  
▲



15X75 / 6"X30"

▼  
9 MM  
▲

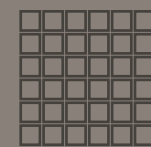

MOSAICO 4,7X4,7  
30X30

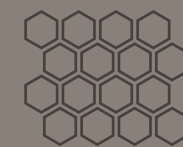

MOSAICO HEXAGONAL  
26X31,5



CHEVRON 1  
20X120

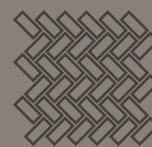

CHEVRON 2  
29,9X29,9



CHEVRON 3  
30X30

## USAGE \_USO

WALL, FLOOR, INTERIOR, EXTERIOR, COMMERCIAL, RESIDENTIAL



PAINTWOOD NATURAL



PAINTWOOD WHITE



PAINTWOOD GREY



PAINTWOOD SMOKE















# PAINTWOOD

GLAZED PORCELAIN TILES \_GRÉS PORCELÂNICO VIDRADO \_GRÈS CÉRAME ÉMAILLÉ  
FEINSTEINZEUG GLASIERT \_GRÉS PORCELÂNICO  
EN 14411:2016 GROUP \_GRUPO \_GROUPE \_GRUPPE Bla



PAINTWOOD NATURAL 20X120 R



PAINTWOOD NATURAL  
GP 0548

PAINTWOOD NATURAL ANTI-SLIP  
GP 0552



PAINTWOOD WHITE  
GP 0549

PAINTWOOD WHITE ANTI-SLIP  
GP 0553



PAINTWOOD GREY  
GP 0550

PAINTWOOD GREY ANTI-SLIP  
GP 0554



PAINTWOOD SMOKE  
GP 0551

PAINTWOOD SMOKE ANTI-SLIP  
GP 0555

## SURFACE \_SUPERFÍCIE

MATT

## FEATURES \_ATRIBUTOS

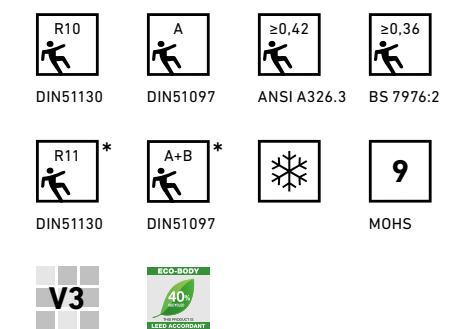

## FINISH \_ACABAMENTO

NATURAL (NAT)  
RECTIFIED (R)

## SIZES \_FORMATOS

20X120 R  
20X120 R ANTI-SLIP\*  
15X75 R  
15X75 R ANTI-SLIP\*  
15X75 NAT  
15X75 NAT ANTI-SLIP\*

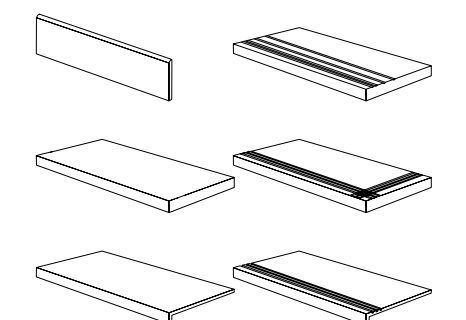

SKIRTINGS \_RODAPÉ 9,5X120  
SKIRTINGS \_RODAPÉ 7X75  
STEP \_DEGRAU 20X120  
STEP \_DEGRAU TEC. 20X120



# MAPLE

 **GLAZED PORCELAIN TILES** \_GRÉS PORCELÂNICO VIDRADO \_GRÈS CÉRAME ÉMAILLÉ  
 **FEINSTEINZEUG GLASIERT** \_GRÉS PORCELÂNICO  
 EN 14411:2016 **GROUP** \_GRUPO \_GROUPE \_GRUPPE **Bl**



MAPLE DARK 15X75 R



MAPLE GREY  
GP 0495



MAPLE NATURAL  
GP 0496











MAPLE DARK  
GP 0497

## SURFACE \_SUPERFÍCIE

MATT

## FEATURES \_ATRIBUTOS

 R10 DIN51130	 A DIN51097	 ≤0.42 ANSI A326.3	 ≥0.36 BS 7976:2
 MOHS	 9	 V3	 ECO-BODY 40+ LEVEL ACCREDITED

## FINISH \_ACABAMENTO

NATURAL (NAT)  
RECTIFIED (R)

## SIZES \_FORMATOS

15X75 R  
15X75 NAT

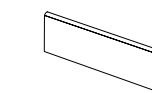

SKIRTINGS \_RODAPÉ 7X75



# VINTAGE

GLAZED PORCELAIN TILES \_GRÉS PORCELÂNICO VIDRADO \_GRÈS CÉRAMÉ ÉMAILLÉ  
FEINSTEINZEUG GLASIERT \_GRÉS PORCELÂNICO  
EN 14411:2016 GROUP \_GRUPO \_GROUPE \_GRUPPE Bla



15X60 / 6"X24"

▼  
8,7 MM  
▲

USAGE\_USO

WALL, FLOOR, INTERIOR, EXTERIOR, COMMERCIAL, RESIDENTIAL



VINTAGE BEGE



VINTAGE CINZA



VINTAGE MEL



VINTAGE CASTANHO



VINTAGE ANTRACITE





LINIA VINTAGE 33X47



# VINTAGE

 **GLAZED PORCELAIN TILES** \_GRÉS PORCELÂNICO VIDRADO \_GRÈS CÉRAME ÉMAILLÉ  
 FEINSTEINZEUG GLASIERT \_GRÉS PORCELÂNICO  
 EN 14411:2016 GROUP \_GRUPO \_GROUPE \_GRUPPE Bla



VINTAGE BEGE DECOR  
GPC 0373



VINTAGE CINZA DECOR  
GPC 0372



VINTAGE MEL DECOR  
GPC 0374



VINTAGE CASTANHO DECOR  
GPC 0375



VINTAGE ANTRACITE DECOR  
GPC 0429

# VINTAGE

 **GLAZED PORCELAIN TILES** \_GRÉS PORCELÂNICO VIDRADO \_GRÈS CÉRAME ÉMAILLÉ  
 FEINSTEINZEUG GLASIERT \_GRÉS PORCELÂNICO  
 EN 14411:2016 GROUP \_GRUPO \_GROUPE \_GRUPPE Bla



VINTAGE BEGE  
GPC 0369



VINTAGE CINZA  
GPC 0368



VINTAGE MEL  
GPC 0370



VINTAGE CASTANHO  
GPC 0371



VINTAGE ANTRACITE  
GPC 0420

## SURFACE \_SUPERFÍCIE

MATT

## FEATURES \_ATRIBUTOS

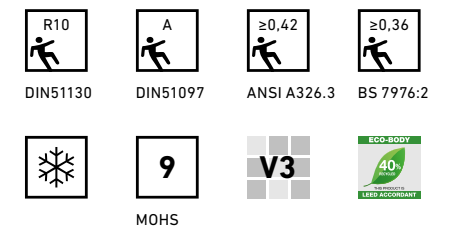

## FINISH \_ACABAMENTO

NATURAL (NAT)

## SIZES \_FORMATOS

15X60 CUT

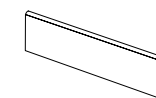

SKIRTINGS \_RODAPÉ 7X60





# DECK

 GLAZED PORCELAIN TILES \_GRÉS PORCELÂNICO VIDRADO \_GRÈS CÉRAME ÉMAILLÉ  
 FEINSTEINZEUG GLASIERT \_GRÉS PORCELÂNICO  
 EN 14411:2016 GROUP \_GRUPO \_GROUPE \_GRUPPE **BIa**

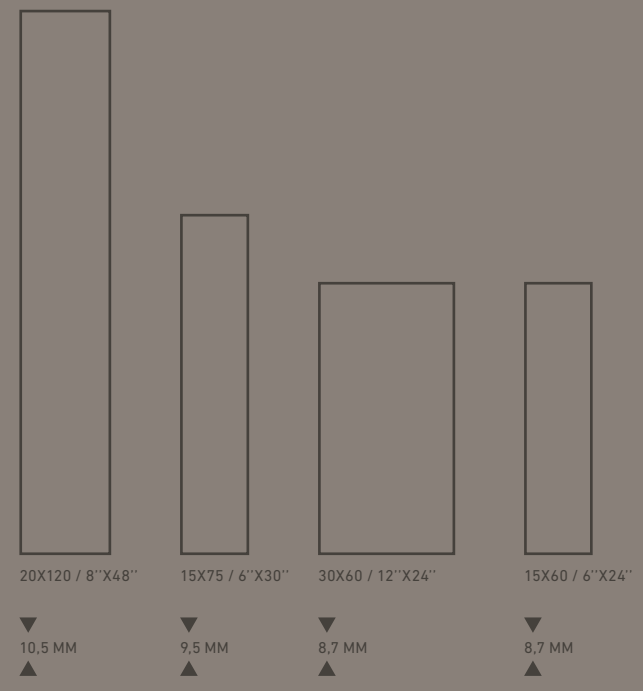

USAGE \_USO

WALL, FLOOR, INTERIOR, EXTERIOR, COMMERCIAL, RESIDENTIAL

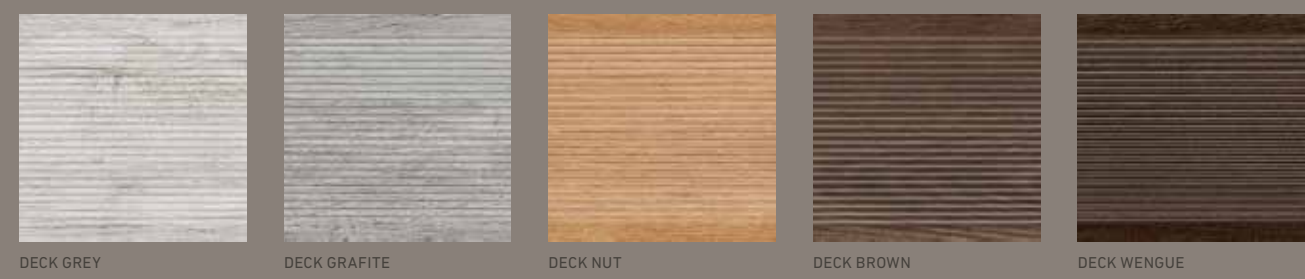

DECK WENGUE 15X60







# DECK

 **GLAZED PORCELAIN TILES** \_GRÉS PORCELÂNICO VIDRADO \_GRÈS CÉRAMÉ ÉMAILLÉ  
 **FEINSTEINZEUG GLASIERT** \_GRÉS PORCELÂNICO  
 EN 14411:2016 **GROUP** \_GRUPO \_GROUPE \_GRUPPE **Bl**



DECK GREY  
GP 0417



DECK GRAFITE  
GP 0418



DECK NUT  
GP 0415



DECK BROWN  
GP 0643



DECK WENGUE  
GP 0419

## SURFACE \_SUPERFÍCIE

MATT ANTI-SLIP

## FEATURES \_ATRIBUTOS

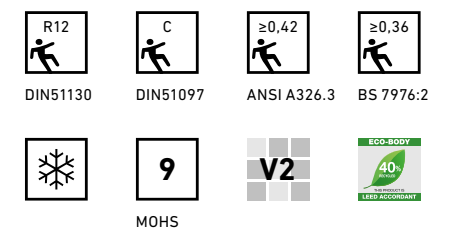

## FINISH \_ACABAMENTO

NATURAL (NAT)  
RECTIFIED (R)

## SIZES \_FORMATOS

20X120 R  
15X75 R  
15X75 NAT  
30X60 NAT  
15X60 CUT

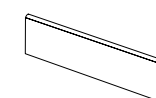

SKIRTINGS \_RODAPÉ 9,5X120  
SKIRTINGS \_RODAPÉ 7X75  
SKIRTINGS \_RODAPÉ 7X60





ANARCHIC CREAM 90X90-R

# ANARCHIC

 **GLAZED PORCELAIN TILES** \_GRÉS PORCELÂNICO VIDRADO \_GRÈS CÉRAMÉ ÉMAILLÉ  
 **FEINSTEINZEUG GLASIERT** \_GRÉS PORCELÂNICO  
 EN 14411:2016 GROUP \_GRUPO \_GROUPE \_GRUPPE **BIa**

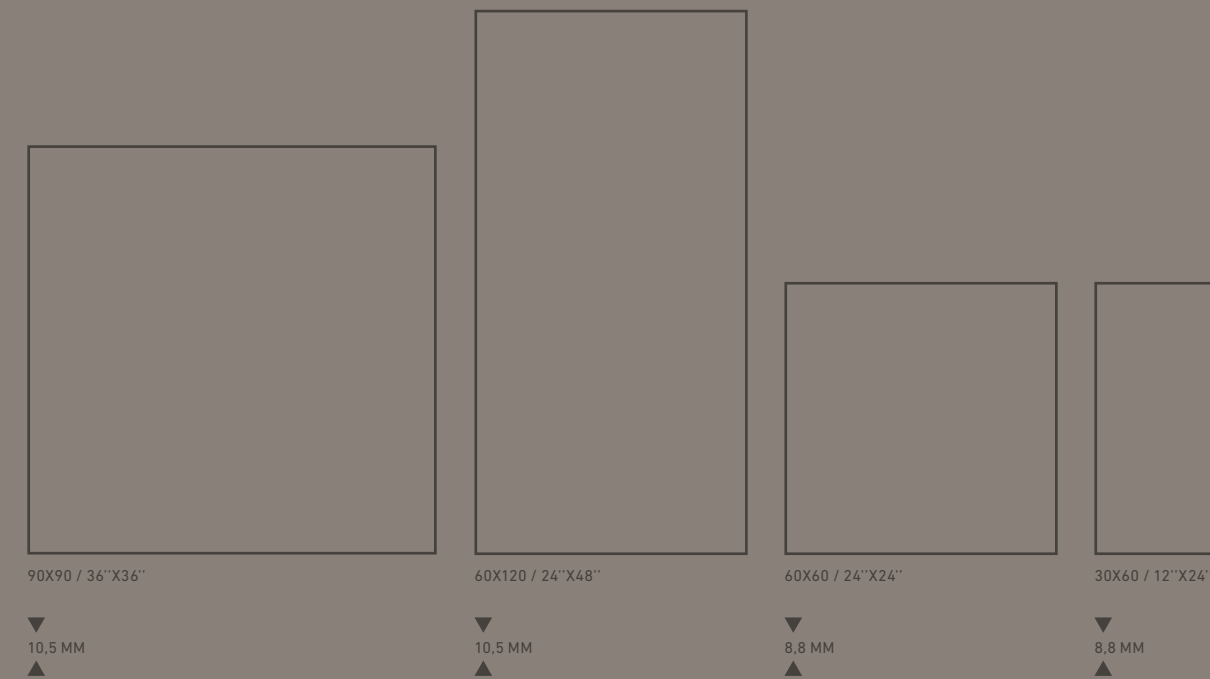

## USAGE \_USO

WALL, FLOOR, INTERIOR, EXTERIOR, COMMERCIAL, RESIDENTIAL



ANARCHIC WHITE ANARCHIC FOG ANARCHIC CREAM ANARCHIC DEBRIS ANARCHIC DARK





ANARCHIC FOG 90X90 R





ANARCHIC DARK 90X90 R



# ANARCHIC

 **GLAZED PORCELAIN TILES** \_GRÉS PORCELÂNICO VIDRADO \_GRÈS CÉRAME ÉMAILLÉ  
 FEINSTEINZEUG GLASIERT \_GRÉS PORCELÂNICO  
 EN 14411:2016 GROUP \_GRUPO \_GROUPE \_GRUPPE **BIa**



ANARCHIC WHITE DECOR  
GP 0702



ANARCHIC FOG DECOR  
GP 0704



ANARCHIC CREAM DECOR  
GP 0705



ANARCHIC DEBRIS DECOR  
GP 0703



ANARCHIC DARK DECOR  
GP 0706

# ANARCHIC

 **GLAZED PORCELAIN TILES** \_GRÉS PORCELÂNICO VIDRADO \_GRÈS CÉRAME ÉMAILLÉ  
 FEINSTEINZEUG GLASIERT \_GRÉS PORCELÂNICO  
 EN 14411:2016 GROUP \_GRUPO \_GROUPE \_GRUPPE **BIa**



ANARCHIC WHITE  
GP 0697



ANARCHIC FOG  
GP 0699



ANARCHIC CREAM  
GP 0700



ANARCHIC DEBRIS  
GP 0698



ANARCHIC DARK  
GP 0701

## SURFACE \_SUPERFÍCIE

MATT

## FEATURES \_ATRIBUTOS

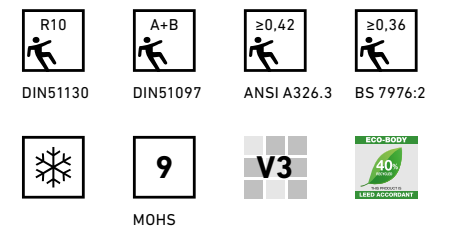

## FINISH \_ACABAMENTO

NATURAL (NAT)  
RECTIFIED (R)

## SIZES \_FORMATOS

90X90 R  
 45X90 R  
 60X120 R  
 60X60 R  
 60X60 NAT  
 30X60 R

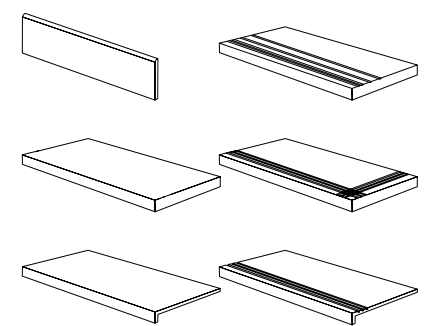

SKIRTINGS \_RODAPÉ 9X90  
 SKIRTINGS \_RODAPÉ 9X120  
 SKIRTINGS \_RODAPÉ 9X60  
 STEP \_DEGRAU 45X90  
 STEP \_DEGRAU 60X120  
 STEP \_DEGRAU 60X60  
 STEP \_DEGRAU TEC. 30X90  
 STEP \_DEGRAU TEC. 30X120  
 STEP \_DEGRAU TEC. 30X60



# SASSI

 **GLAZED PORCELAIN TILES** \_GRÉS PORCELÂNICO VIDRADO \_GRÈS CÉRAMÉ ÉMAILLÉ  
 **FEINSTEINZEUG GLASIERT** \_GRÉS PORCELÂNICO  
 EN 14411:2016 GROUP \_GRUPO \_GROUPE \_GRUPPE **Bl**

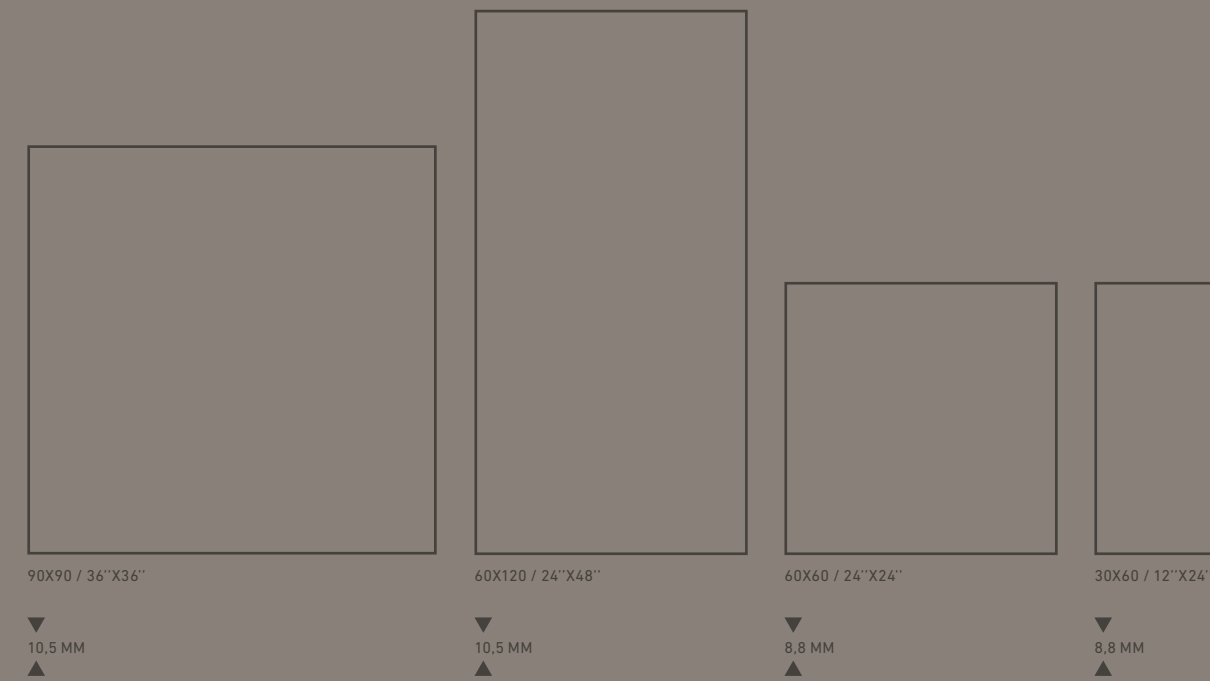

## USAGE \_USO

WALL, FLOOR, INTERIOR, EXTERIOR, COMMERCIAL, RESIDENTIAL



SASSI WHITE



SASSI FOG



SASSI TAUPE



SASSI SMOKE

SASSI FOG 60X60 R  
SASSI FOG 30X60 R



# SASSI

GLAZED PORCELAIN TILES \_GRÉS PORCELÂNICO VIDRADO \_GRÈS CÉRAME ÉMAILLÉ  
FEINSTEINZEUG GLASIERT \_GRÉS PORCELÂNICO  
EN 14411:2016 GROUP \_GRUPO \_GROUPE \_GRUPPE Bla



SASSI TAUPE 30X60 R



SASSI WHITE  
GP 0655



SASSI FOG  
GP 0656



SASSI TAUPE  
GP 0657



SASSI SMOKE  
GP 0658

## SURFACE \_SUPERFÍCIE

MATT

## FEATURES \_ATRIBUTOS

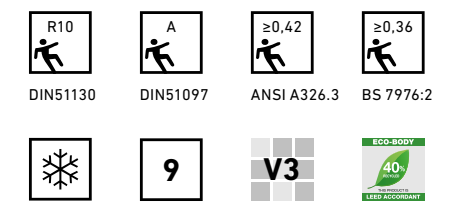

## FINISH \_ACABAMENTO

NATURAL (NAT)  
RECTIFIED (R)

## SIZES \_FORMATOS

90X90 R  
45X90 R  
60X120 R  
60X60 R  
60X60 NAT  
30X60 R

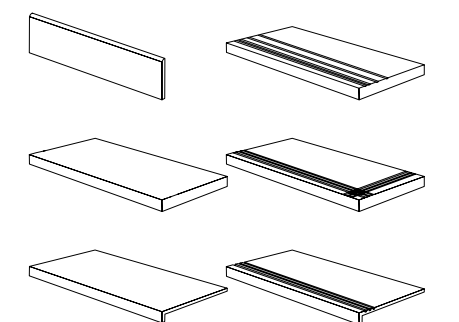

SKIRTINGS \_RODAPÉ 9X90

SKIRTINGS \_RODAPÉ 9X120

SKIRTINGS \_RODAPÉ 9X60

STEP \_DEGRAU 45X90

STEP \_DEGRAU 60X120

STEP \_DEGRAU 60X60

STEP \_DEGRAU TEC. 30X90

STEP \_DEGRAU TEC. 30X120

STEP \_DEGRAU TEC. 30X60



# URBAN CONCRETE

GLAZED PORCELAIN TILES \_GRÉS PORCELÂNICO VIDRADO \_GRÈS CÉRAME ÉMAILLÉ  
 FEINSTEINZEUG GLASIERT \_GRÉS PORCELÁNICO  
 EN 14411:2016 GROUP \_GRUPO \_GROUPE \_GRUPPE Bla

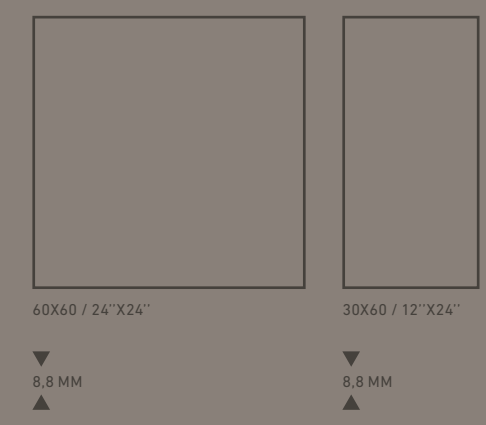

USAGE \_USO

WALL, FLOOR, INTERIOR, EXTERIOR, COMMERCIAL, RESIDENTIAL



URBAN CONCRETE CREAM 60X60 R



# URBAN CONCRETE

 **GLAZED PORCELAIN TILES** \_GRÉS PORCELÂNICO VIDRADO \_GRÈS CÉRAME ÉMAILLÉ  
 **FEINSTEINZEUG GLASIERT** \_GRÉS PORCELÂNICO  
 EN 14411:2016 GROUP \_GRUPO \_GROUPE \_GRUPPE Bla



URBAN CONCRETE FOG 60X60 R



URBAN CONCRETE SAND  
GP 0665



URBAN CONCRETE CREAM  
GP 0666



URBAN CONCRETE FOG  
GP 0667



URBAN CONCRETE SMOKE  
GP 0668



URBAN CONCRETE DECOR FOG  
GP 0669



URBAN CONCRETE DECOR CREAM  
GP 0670

## SURFACE \_SUPERFÍCIE

MATT

## FEATURES \_ATRIBUTOS

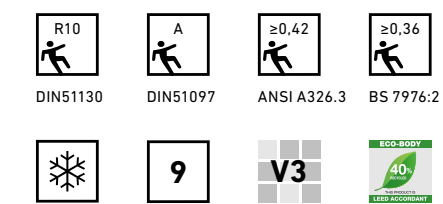

## FINISH \_ACABAMENTO

NATURAL (NAT)  
RECTIFIED (R)

## SIZES \_FORMATOS

60X60 R  
60X60 NAT  
30X60 R

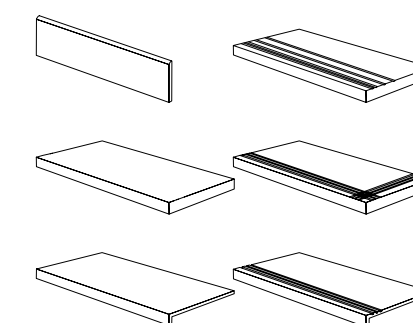

SKIRTINGS \_RODAPE 9X60  
 STEP \_DEGRAU 60X60  
 STEP \_DEGRAU TEC. 30X60



# CEMENTONE

GLAZED PORCELAIN TILES \_GRÉS PORCELÂNICO VIDRADO \_GRÈS CÉRAMÉ ÉMAILLÉ  
FEINSTEINZEUG GLASIERT \_GRÉS PORCELÂNICO  
EN 14411:2016 GROUP \_GRUPO \_GROUPE \_GRUPPE Bl



CEMENTONE CAMOU 60X60



60X60 / 24"X24"

▼  
8,8 MM  
▲

30X60 / 12"X24"

▼  
8,8 MM  
▲

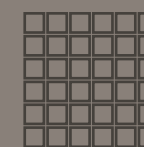

MOSAICO 4,7X4,7  
30X30



MOSAICO LOSANGO  
23,6X28

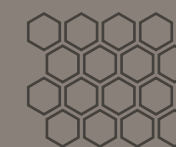

MOSAICO HEXAGONAL  
26X31,5

## USAGE \_USO

WALL, FLOOR, INTERIOR, EXTERIOR, COMMERCIAL, RESIDENTIAL



CEMENTONE SAND



CEMENTONE GREY



CEMENTONE SMOKE



CEMENTONE DARK



# CEMENTONE

 GLAZED PORCELAIN TILES \_GRÉS PORCELÂNICO VIDRADO \_GRÈS CÉRAMÉ ÉMAILLÉ  
 FEINSTEINZEUG GLASIERT \_GRÉS PORCELÂNICO  
 EN 14411:2016 GROUP \_GRUPO \_GROUPE \_GRUPPE Bla



CEMENTONE GREY 60X60 R

## SURFACE \_SUPERFÍCIE

MATT

## FEATURES \_ATRIBUTOS

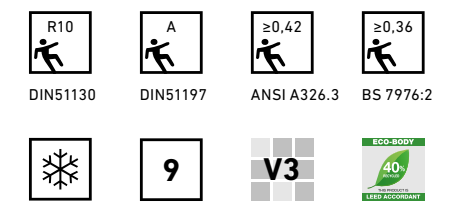

## FINISH \_ACABAMENTO

NATURAL (NAT)  
RECTIFIED (R)

## SIZES \_FORMATOS

60X60 R  
60X60 NAT  
30X60 R

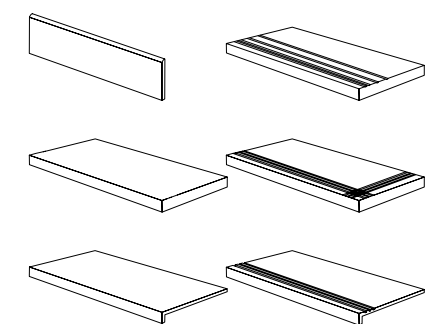

SKIRTINGS \_RODAPE 9X60  
 STEP \_DEGRAU 60X60  
 STEP \_DEGRAU TEC. 30X60



CEMENTONE SAND  
GP 0659



CEMENTONE GREY  
GP 0660



CEMENTONE SMOKE  
GP 0661



CEMENTONE DARK  
GP 0662



CEMENTONE CAMOU  
GP 0663

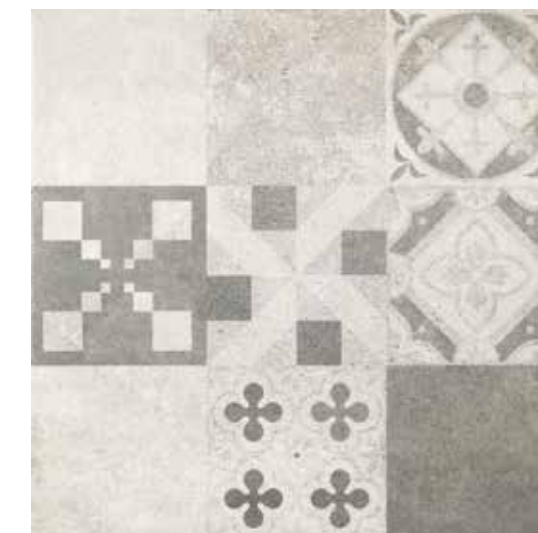

CEMENTONE HIDRÁULICO  
GP 0664





LIVING FOG 60X60

# LIVING

GLAZED PORCELAIN TILES \_GRÉS PORCELÂNICO VIDRADO \_GRÈS CÉRAMÉ ÉMAILLÉ  
 FEINSTEINZEUG GLASIERT \_GRÉS PORCELÁNICO  
 EN 14411:2016 GROUP \_GRUPO \_GROUPE \_GRUPPE **Bl**a

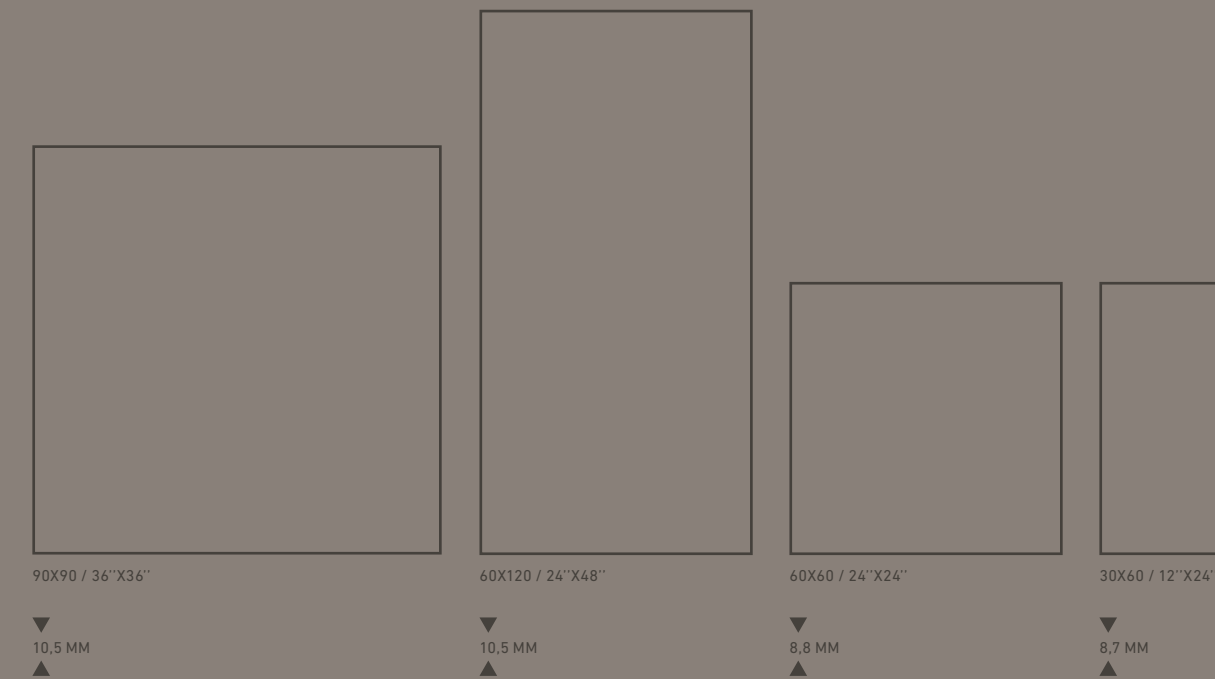

## USAGE \_USO

WALL, FLOOR, INTERIOR, EXTERIOR, COMMERCIAL, RESIDENTIAL



LIVING CREAM    LIVING TORTORA    LIVING FOG    LIVING SMOKE



# LIVING

GLAZED PORCELAIN TILES \_GRÉS PORCELÂNICO VIDRADO \_GRÈS CÉRAME ÉMAILLÉ  
FEINSTEINZEUG GLASIERT \_GRÉS PORCELÂNICO  
EN 14411:2016 GROUP \_GRUPO \_GROUPE \_GRUPPE Bla



LIVING SMOKE 60X60



LIVING CREAM  
GP 0541



LIVING TORTORA  
GP 0542



LIVING FOG  
GP 0543



LIVING SMOKE  
GP 0544

## SURFACE \_SUPERFÍCIE

MATT

## FEATURES \_ATRIBUTOS

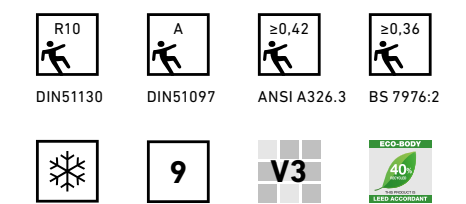

## FINISH \_ACABAMENTO

NATURAL (NAT)  
RECTIFIED (R)

## SIZES \_FORMATOS

90X90 R  
45X90 R  
60X120 R  
60X60 R  
60X60 NAT  
30X60 R  
30X60 NAT

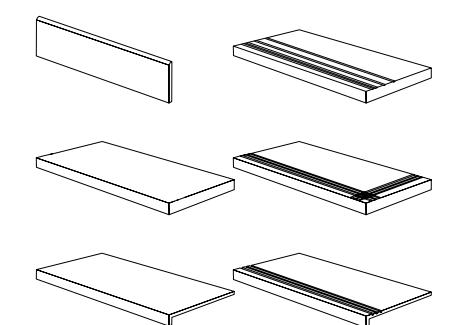

SKIRTINGS \_RODAPÉ 9X90  
SKIRTINGS \_RODAPÉ 9X120  
SKIRTINGS \_RODAPÉ 9X60  
STEP \_DEGRAU 45X90  
STEP \_DEGRAU 60X120  
STEP \_DEGRAU 60X60  
STEP \_DEGRAU TEC. 30X90  
STEP \_DEGRAU TEC. 30X120  
STEP \_DEGRAU TEC. 30X60



# LIVING LINES & SQUARES

 **GLAZED PORCELAIN TILES** \_GRÉS PORCELÂNICO VIDRADO \_GRÈS CÉRAME ÉMAILLÉ  
FEINSTEINZEUG GLASIERT \_GRÉS PORCELÁNICO  
EN 14411:2016 GROUP \_GRUPO \_GROUPE \_GRUPPE Bla



LINES LIGHT  
GP 0606



LINES DARK  
GP 0607



SQUARES LIGHT  
GP 0608



SQUARES DARK  
GP 0609

**SURFACE** \_SUPERFÍCIE

MATT

**FEATURES** \_ATRIBUTOS



**FINISH** \_ACABAMENTO

NATURAL (NAT)

**SIZES** \_FORMATOS

30X60 NAT



SQUARES DARK 30X60  
LIVING FOG 60X60





LIVING HIDRÁULICO.FOG 60X60



# LIVING HIDRÁULICO

GLAZED PORCELAIN TILES \_GRÉS PORCELÂNICO VIDRADO \_GRÈS CÉRAME ÉMAILLÉ  
FEINSTEINZEUG GLASIERT \_GRÉS PORCELÁNICO  
EN 14411:2016 GROUP \_GRUPO \_GROUPE \_GRUPPE Bla

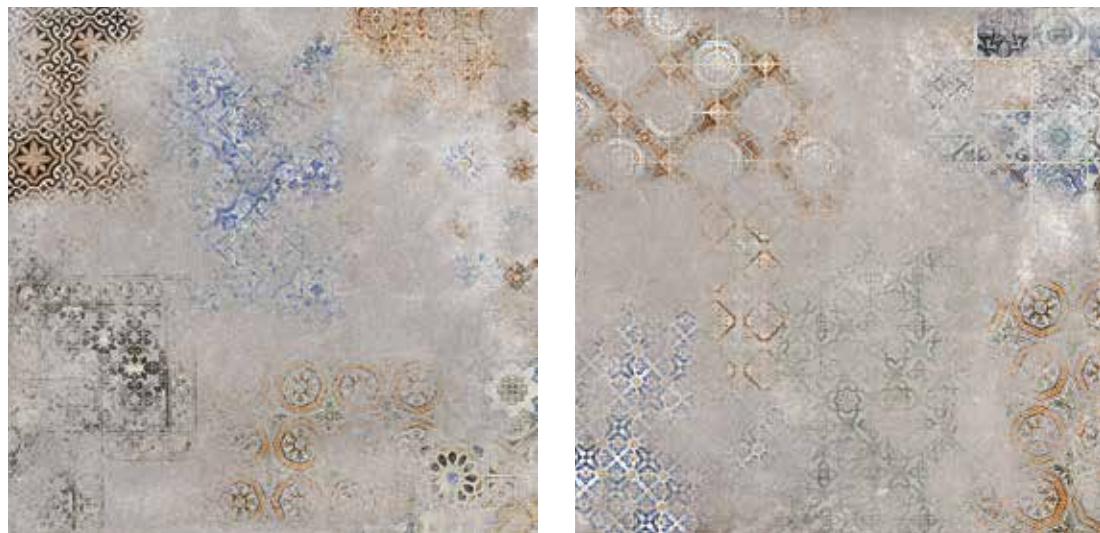
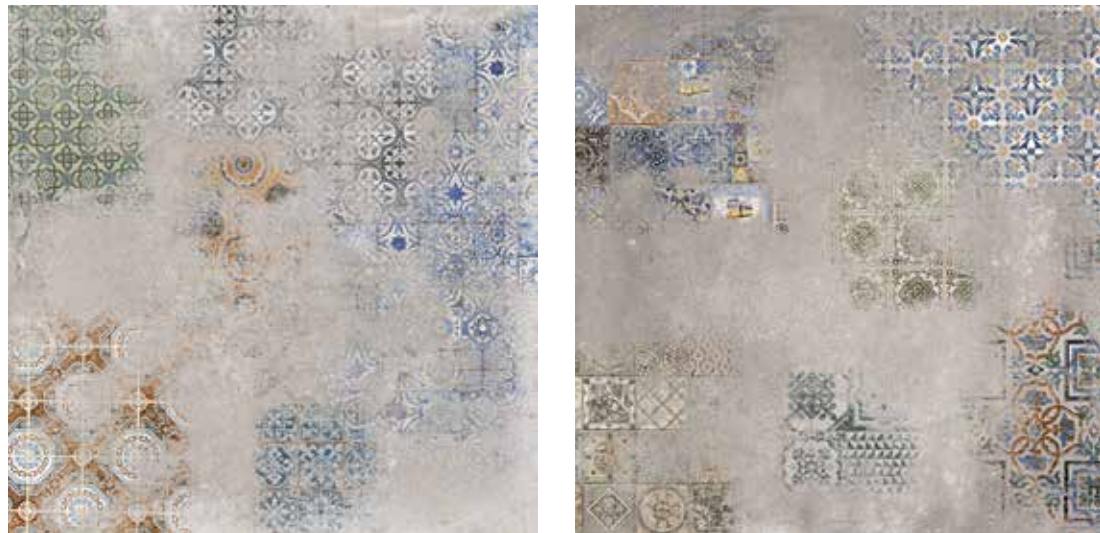

LIVING HIDRÁULICO FOG  
GP 0584

# LIVING HIDRÁULICO

GLAZED PORCELAIN TILES \_GRÉS PORCELÂNICO VIDRADO \_GRÈS CÉRAME ÉMAILLÉ  
FEINSTEINZEUG GLASIERT \_GRÉS PORCELÁNICO  
EN 14411:2016 GROUP \_GRUPO \_GROUPE \_GRUPPE Bla

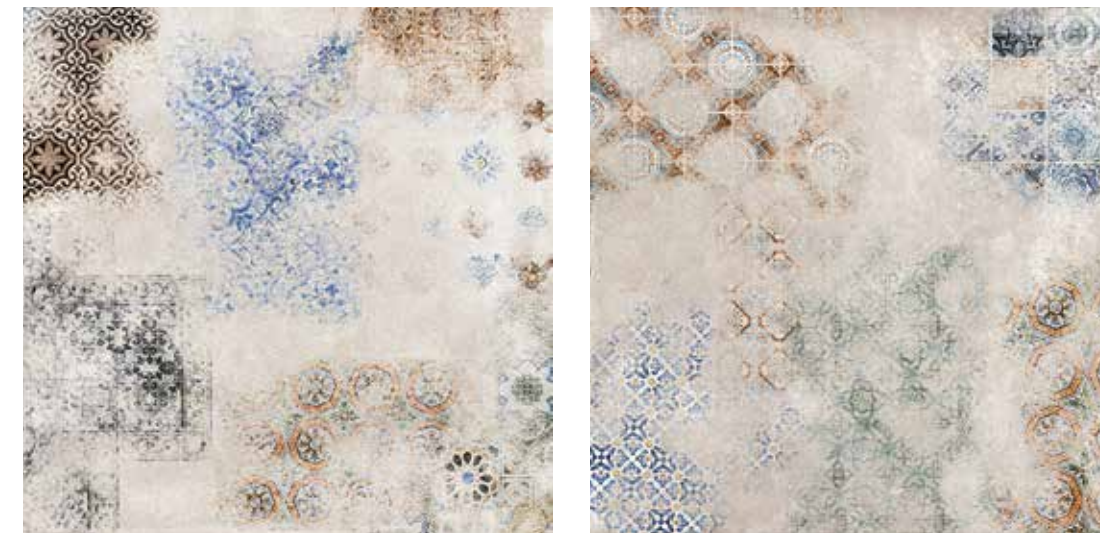

LIVING HIDRÁULICO CREAM  
GP 0583

## SURFACE \_SUPERFÍCIE

MATT

## FEATURES \_ATRIBUTOS

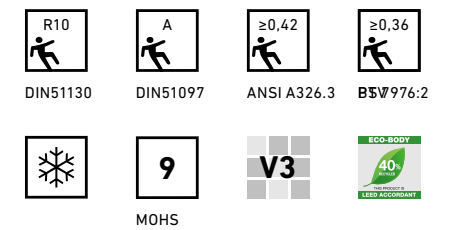

## FINISH \_ACABAMENTO

NATURAL (NAT)  
RECTIFIED (R)

## SIZES \_FORMATOS

60X60 R  
60X60 NAT



# RUSTY

 **GLAZED PORCELAIN TILES** \_GRÉS PORCELÂNICO VIDRADO \_GRÈS CÉRAMÉ ÉMAILLÉ  
 **FEINSTEINZEUG GLASIERT** \_GRÉS PORCELÁNICO  
 EN 14411:2016 GROUP \_GRUPO \_GROUPE \_GRUPPE **Bl**a



RUSTY FOG 60X60



60X60 / 24\"/>

▼  
8,8 MM  
▲

30X60 / 12\"/>

▼  
8,7 MM  
▲

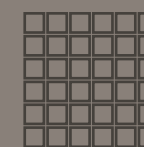

MOSAICO 4,7X4,7  
30X30



MOSAICO LOSANGO  
23,6X28

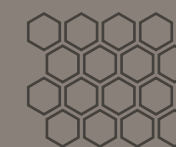

MOSAICO HEXAGONAL  
26X31,5

## USAGE \_USO

WALL, FLOOR, INTERIOR, EXTERIOR, COMMERCIAL, RESIDENTIAL



RUSTY SAND



RUSTY ASH



RUSTY FOG



RUSTY SMOKE



RUSTY BROWN



# RUSTY

GLAZED PORCELAIN TILES \_GRÉS PORCELÂNICO VIDRADO \_GRÈS CÉRAMÉ ÉMAILLÉ  
FEINSTEINZEUG GLASIERT \_GRÉS PORCELÂNICO  
EN 14411:2016 GROUP \_GRUPO \_GROUPE \_GRUPPE Bla



RUSTY SAND  
GP 0535



RUSTY ASH  
GP 0536



RUSTY FOG  
GP 0537



RUSTY SMOKE  
GP 0538



RUSTY BROWN  
GP 0539



RUSTY DECOR  
GP 0540

## SURFACE \_SUPERFÍCIE

MATT

## FEATURES \_ATRIBUTOS

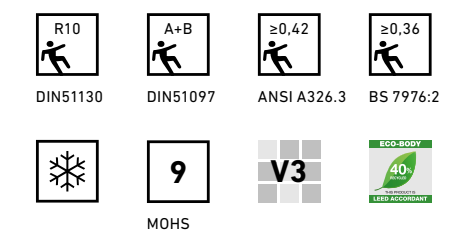

## FINISH \_ACABAMENTO

NATURAL (NAT)  
RECTIFIED (R)

## SIZES \_FORMATOS

60X60 R  
60X60 NAT  
30X60 R  
30X60 NAT

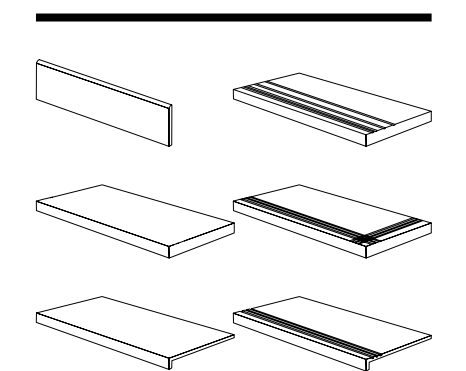

SKIRTINGS \_RODAPÉ 9X60  
STEP \_DEGRAU 60X60  
STEP \_DEGRAU TEC. 30X60





BETON NUT 60X60

# BETON

 GLAZED PORCELAIN TILES \_GRÉS PORCELÂNICO VIDRADO \_GRÈS CÉRAMÉ ÉMAILLÉ  
 FEINSTEINZEUG GLASIERT \_GRÉS PORCELÂNICO  
 EN 14411:2016 GROUP \_GRUPO \_GROUPE \_GRUPPE **Bl**

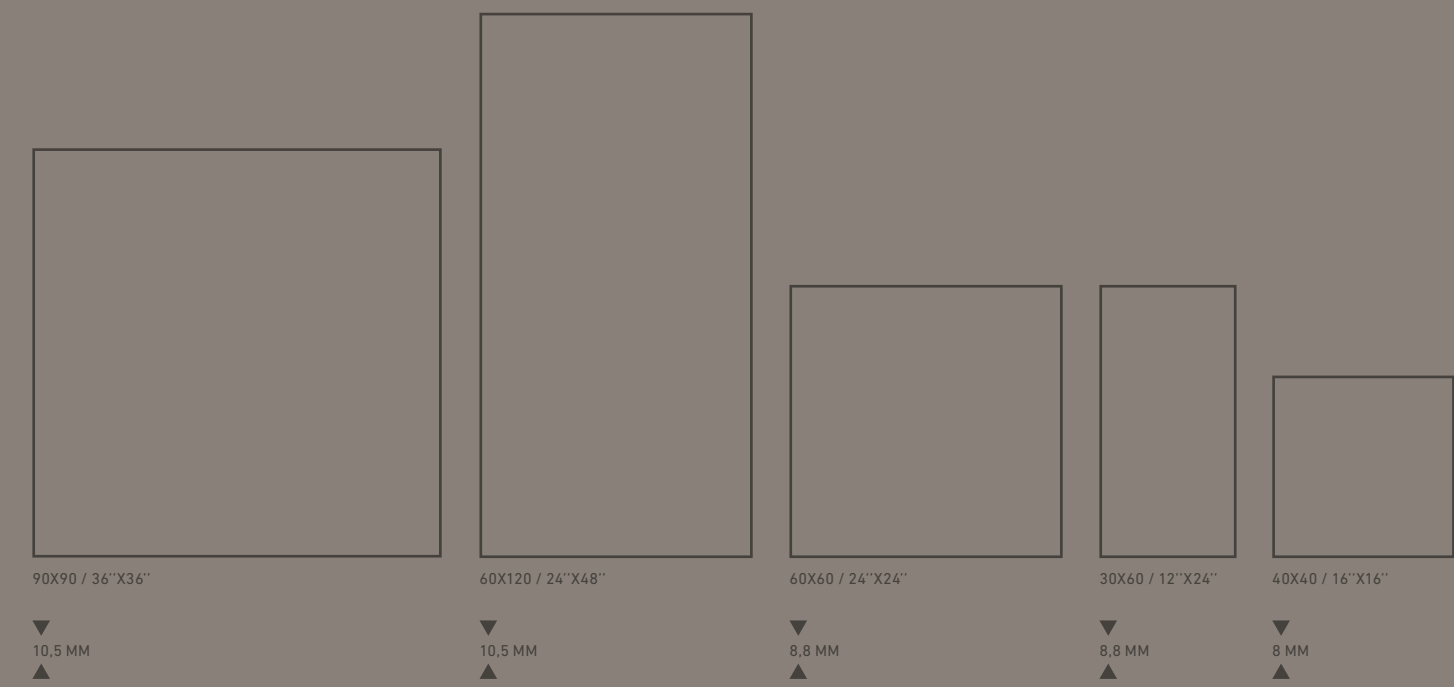

## USAGE \_USO

WALL, FLOOR, INTERIOR, EXTERIOR, COMMERCIAL, RESIDENTIAL



BETON WHITE



BETON FOG



BETON NUT



BETON SMOKE





BETON FOG 90X90





BETON NUT 60X60  
BETON HIDRÁULICO 60X60  
BRICK CASTANHO 33X47



# BETON

 **GLAZED PORCELAIN TILES** \_GRÉS PORCELÂNICO VIDRADO \_GRÈS CÉRAME ÉMAILLÉ  
 **FEINSTEINZEUG GLASIERT** \_GRÉS PORCELÂNICO  
 EN 14411:2016 **GROUP** \_GRUPO \_GROUPE \_GRUPPE **Bl**



BETON FOG 60X60



BETON WHITE  
GP 0438



BETON FOG  
GP 0439



BETON NUT  
GP 0440



BETON SMOKE  
GP 0441

## SURFACE \_SUPERFÍCIE

MATT  
SEMI-POLISHED (SP)

## FEATURES \_ATRIBUTOS

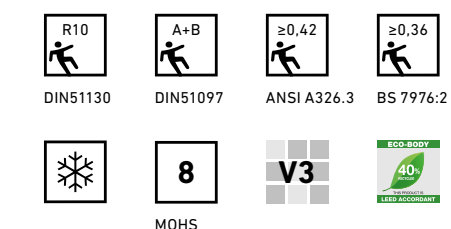

## FINISH \_ACABAMENTO

NATURAL (NAT)  
RECTIFIED (R)

## SIZES \_FORMATOS

90X90 R  
90X90 SP  
45X90 R  
45X90 SP  
60X120 R  
60X120 SP  
60X60 R  
60X60 SP  
60X60 NAT  
30X60 R  
30X60 SP  
40X40 NAT

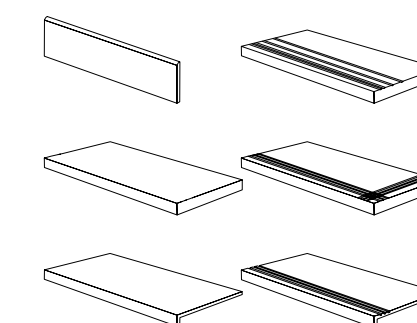

SKIRTINGS \_RODAPÉ 9X90

SKIRTINGS \_RODAPÉ 9X120

SKIRTINGS \_RODAPÉ 9X60

SKIRTINGS \_RODAPÉ 8X40

STEP \_DEGRAU 45X90

STEP \_DEGRAU 60X120

STEP \_DEGRAU 60X60

STEP \_DEGRAU 40X40

STEP \_DEGRAU TEC. 30X90

STEP \_DEGRAU TEC. 30X120

STEP \_DEGRAU TEC. 30X60



# BETON HIDRÁULICO

GLAZED PORCELAIN TILES \_GRÉS PORCELÂNICO VIDRADO \_GRÈS CÉRAME ÉMAILLÉ  
FEINSTEINZEUG GLASIERT \_GRÉS PORCELÁNICO  
EN 14411:2016 GROUP \_GRUPO \_GROUPE \_GRUPPE Bla



BETON FOG 60X60  
BETON HIDRÁULICO 60X60



BETON HIDRÁULICO DECOR  
GP 0468

PEÇAS EMBALADAS ALEATORIAMENTE POR CAIXA  
TILES ARE PACKED RANDOMLY IN THE SAME BOX

## SURFACE \_SUPERFÍCIE

MATT

## FEATURES \_ATRIBUTOS

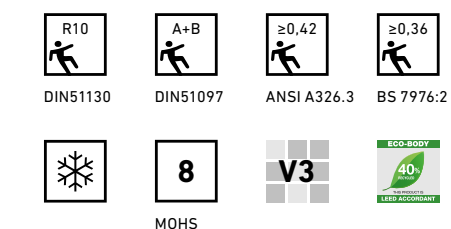

## FINISH \_ACABAMENTO

NATURAL (NAT)

## SIZES \_FORMATOS

60X60 NAT



# BETON PATCHWORK

GLAZED PORCELAIN TILES \_GRÉS PORCELÂNICO VIDRADO \_GRÈS CÉRAMÉ ÉMAILLÉ  
FEINSTEINZEUG GLASIERT \_GRÉS PORCELÁNICO  
EN 14411:2016 GROUP \_GRUPO \_GROUPE \_GRUPPE Bla



BETON PATCHWORK 30X60

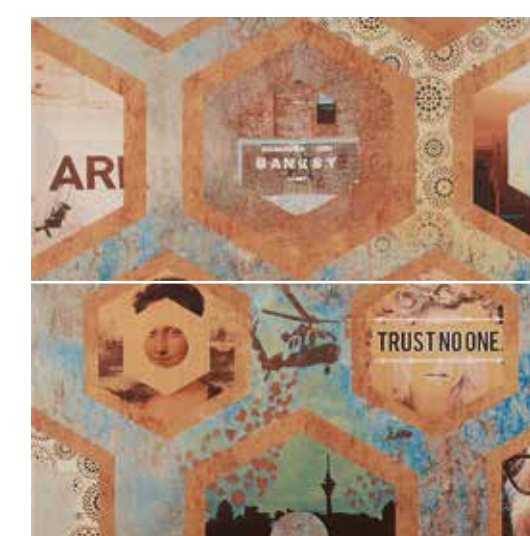
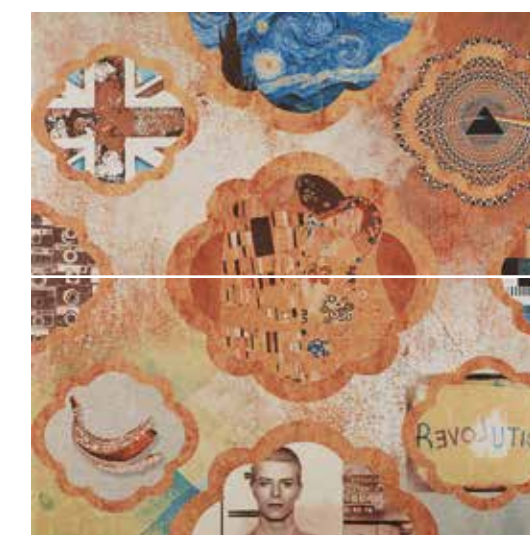

BETON PATCHWORK  
GP 0452

PEÇAS EMBALADAS ALEATORIAMENTE POR CAIXA  
TILES ARE PACKED RANDOMLY IN THE SAME BOX

## SURFACE \_SUPERFÍCIE

MATT

## FEATURES \_ATRIBUTOS

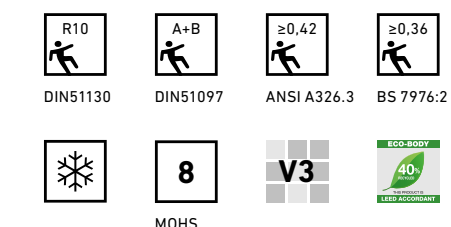

## FINISH \_ACABAMENTO

NATURAL (NAT)  
RECTIFIED (R)

## SIZES \_FORMATOS

60X60 R  
60X60 NAT  
30X60 R



# HERITAGE

GLAZED PORCELAIN TILES \_GRÉS PORCELÂNICO VIDRADO \_GRÈS CÉRAMÉ ÉMAILLÉ  
FEINSTEINZEUG GLASIERT \_GRÉS PORCELÁNICO  
EN 14411:2016 GROUP \_GRUPO \_GROUPE \_GRUPPE Bl



40X40 / 16"X16"

▼  
8 MM



USAGE \_USO

WALL, FLOOR, INTERIOR, EXTERIOR, COMMERCIAL, RESIDENTIAL



HERITAGE GREY



HERITAGE COLOR



HERITAGE MIX GREY



HERITAGE MIX COLOR





BETON HERITAGE GREY 40X40





BETON HERITAGE MIX 40X40



# HERITAGE GREY

GLAZED PORCELAIN TILES \_GRÉS PORCELÂNICO VIDRADO \_GRÈS CÉRAMÉ ÉMAILLÉ  
FEINSTEINZEUG GLASIERT \_GRÉS PORCELÂNICO  
EN 14411:2016 GROUP \_GRUPO \_GROUPE \_GRUPPE Bl



HERITAGE GREY 1  
GP 0679



HERITAGE GREY 2  
GP 0680



HERITAGE GREY 3  
GP 0681



HERITAGE GREY 4  
GP 0682



HERITAGE GREY 5  
GP 0683



HERITAGE GREY 6  
GP 0684

# HERITAGE COLOR

GLAZED PORCELAIN TILES \_GRÉS PORCELÂNICO VIDRADO \_GRÈS CÉRAMÉ ÉMAILLÉ  
FEINSTEINZEUG GLASIERT \_GRÉS PORCELÂNICO  
EN 14411:2016 GROUP \_GRUPO \_GROUPE \_GRUPPE Bl



HERITAGE COLOR 1  
GP 0685



HERITAGE COLOR 2  
GP 0686



HERITAGE COLOR 3  
GP 0687



HERITAGE COLOR 4  
GP 0688



HERITAGE COLOR 5  
GP 0689



HERITAGE COLOR 6  
GP 0690

## SURFACE \_SUPERFÍCIE

MATT

## FEATURES \_ATRIBUTOS

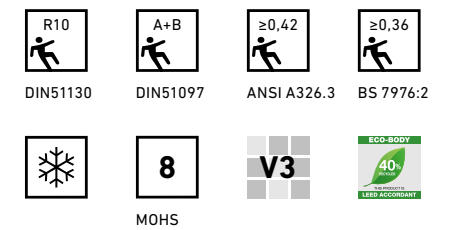

## FINISH \_ACABAMENTO

NATURAL (NAT)  
PRE-CUT

## SIZES \_FORMATOS

40X40 NAT



# HERITAGE MIX GREY

GLAZED PORCELAIN TILES \_GRÉS PORCELÂNICO VIDRADO \_GRÈS CÉRAME ÉMAILLÉ  
FEINSTEINZEUG GLASIERT \_GRÉS PORCELÂNICO  
EN 14411:2016 GROUP \_GRUPO \_GROUPE \_GRUPPE Bl

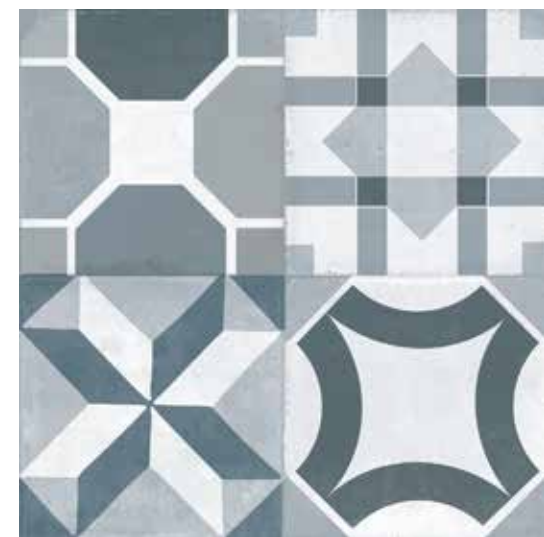
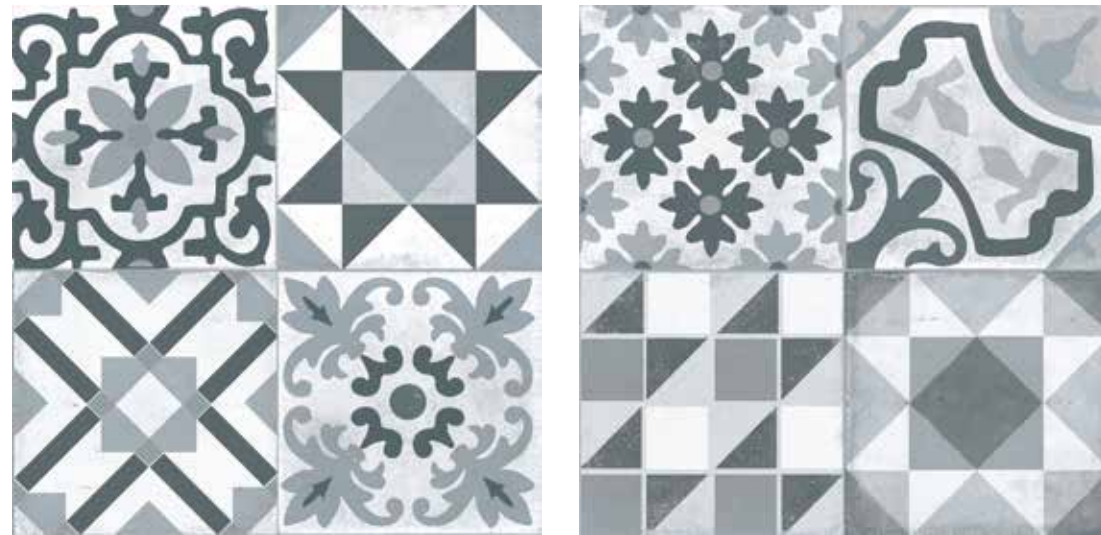

HERITAGE MIX GREY  
GP 0492

# HERITAGE MIX COLOR

GLAZED PORCELAIN TILES \_GRÉS PORCELÂNICO VIDRADO \_GRÈS CÉRAME ÉMAILLÉ  
FEINSTEINZEUG GLASIERT \_GRÉS PORCELÂNICO  
EN 14411:2016 GROUP \_GRUPO \_GROUPE \_GRUPPE Bl



HERITAGE MIX COLOR  
GP 0493

PEÇAS EMBALADAS ALEATORIAMENTE POR CAIXA  
TILES ARE PACKED RANDOMLY IN THE SAME BOX

## SURFACE \_SUPERFÍCIE

MATT

## FEATURES \_ATRIBUTOS

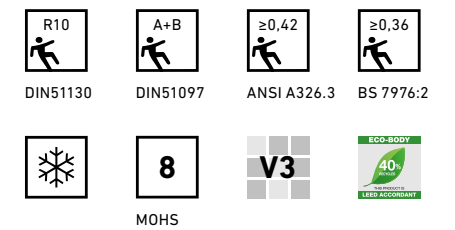

## FINISH \_ACABAMENTO

NATURAL (NAT)  
PRE-CUT

## SIZES \_FORMATOS

40X40 NAT



# FORM

 GLAZED PORCELAIN TILES \_GRÉS PORCELÂNICO VIDRADO \_GRÈS CÉRAME ÉMAILLÉ  
 FEINSTEINZEUG GLASIERT \_GRÉS PORCELÂNICO  
 EN 14411:2016 GROUP \_GRUPO \_GROUPE \_GRUPPE Bla



FORM FOG 30X60  
BETON FOG 60X60



30X60 / 12"X24"

▼  
8,7 MM  
▲

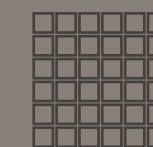

MOSAICO 4,7X4,7  
30X30



MOSAICO LOSANGO  
23,6X28



MOSAICO HEXAGONAL  
26X31,5

## USAGE \_USO

WALL, FLOOR, INTERIOR, EXTERIOR, COMMERCIAL, RESIDENTIAL



FORM WHITE



FORM FOG



FORM NUT



FORM SMOKE





FORM WHITE 30X60



# FORM

 **GLAZED PORCELAIN TILES** \_GRÉS PORCELÂNICO VIDRADO \_GRÈS CÉRAME ÉMAILLÉ  
 **FEINSTEINZEUG GLASIERT** \_GRÉS PORCELÂNICO  
 EN 14411:2016 GROUP \_GRUPO \_GROUPE \_GRUPPE Bla



FORM WHITE  
GP 0442



FORM FOG  
GP 0443



FORM NUT  
GP 0444



FORM SMOKE  
GP 0445

## SURFACE \_SUPERFÍCIE

MATT

## FEATURES \_ATRIBUTOS

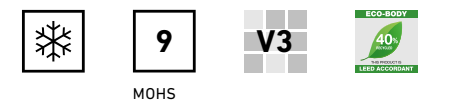
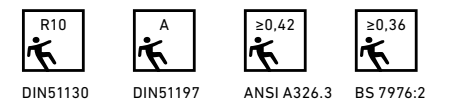

## FINISH \_ACABAMENTO

NATURAL (NAT)  
RECTIFIED (R)

## SIZES \_FORMATOS

30X60 R  
30X60 NAT

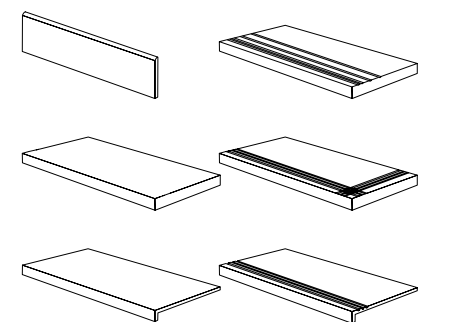

SKIRTINGS \_RODAPÉ 9X60

STEP \_DEGRAU 30X60

STEP \_DEGRAU TEC. 30X60

FORM NUT 30X60  
MOSAICO FORM NUT 4,7X4,7



# MATRIX

 **GLAZED PORCELAIN TILES** \_GRÉS PORCELÂNICO VIDRADO \_GRÈS CÉRAME ÉMAILLÉ  
 **FEINSTEINZEUG GLASIERT** \_GRÉS PORCELÂNICO  
 EN 14411:2016 GROUP \_GRUPO \_GROUPE \_GRUPPE **BIa**

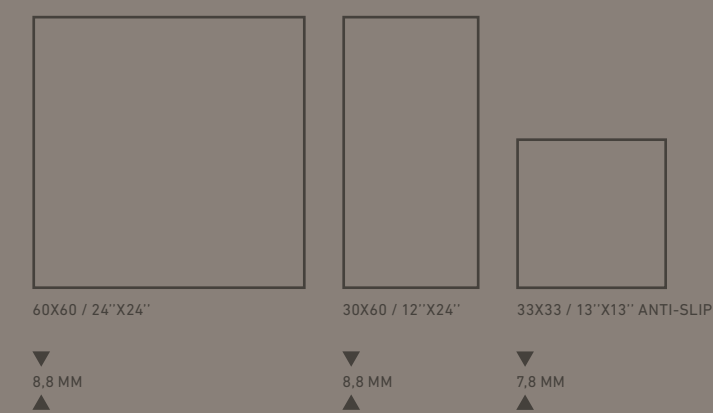

## USAGE \_USO

WALL, FLOOR, INTERIOR, COMMERCIAL, RESIDENTIAL / EXTERIOR ONLY 33X33 ANTI-SLIP



MATRIX BEGE      MATRIX PISTACHIO      MATRIX ESTANHO      MATRIX NOZ      MATRIX CINZA

MATRIX PISTACHIO 60X60



# MATRIX

 **GLAZED PORCELAIN TILES** \_GRÉS PORCELÂNICO VIDRADO \_GRÈS CÉRAME ÉMAILLÉ  
 **FEINSTEINZEUG GLASIERT** \_GRÉS PORCELÂNICO  
 EN 14411:2016 GROUP \_GRUPO \_GROUPE \_GRUPPE Bla



MATRIX BEGE  
GP 0352

MATRIX BEGE ANTI-SLIP  
GP 0475



MATRIX PISTACHIO  
GP 0354

MATRIX PISTACHIO ANTI-SLIP  
GP 0477



MATRIX ESTANHO  
GP 0355

MATRIX ESTANHO ANTI-SLIP  
GP 0478

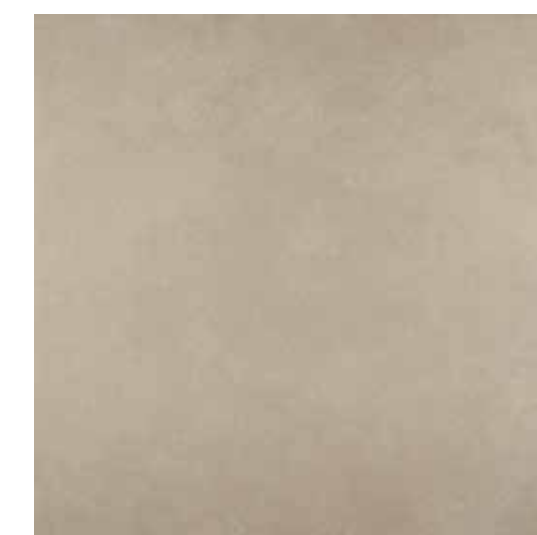

MATRIX NOZ  
GP 0356

MATRIX NOZ ANTI-SLIP  
GP 0479



MATRIX CINZA  
GP 0353

MATRIX CINZA ANTI-SLIP  
GP 0476

## SURFACE \_SUPERFÍCIE

MATT

## FEATURES \_ATRIBUTOS

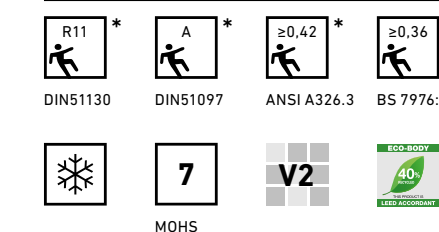

## FINISH \_ACABAMENTO

NATURAL (NAT)  
RECTIFIED (R)

## SIZES \_FORMATOS

60X60 R  
60X60 NAT  
30X60 R  
33X33 ANTI-SLIP\*

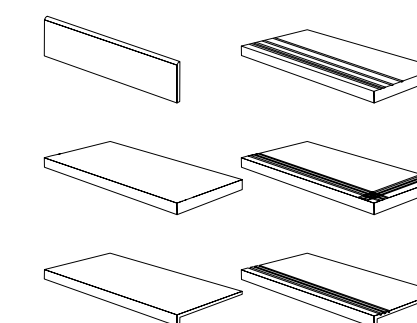

SKIRTINGS \_RODAPE 9X60

SKIRTINGS \_RODAPE 8X33

STEP \_DEGRAU 60X60

STEP \_DEGRAU 33X33

STEP \_DEGRAU TEC. 30X60



# AVANT

GLAZED PORCELAIN TILES \_GRÉS PORCELÂNICO VIDRADO \_GRÈS CÉRAMÉ ÉMAILLÉ  
FEINSTEINZEUG GLASIERT \_GRÉS PORCELÂNICO  
EN 14411:2016 GROUP \_GRUPO \_GROUPE \_GRUPPE Bla

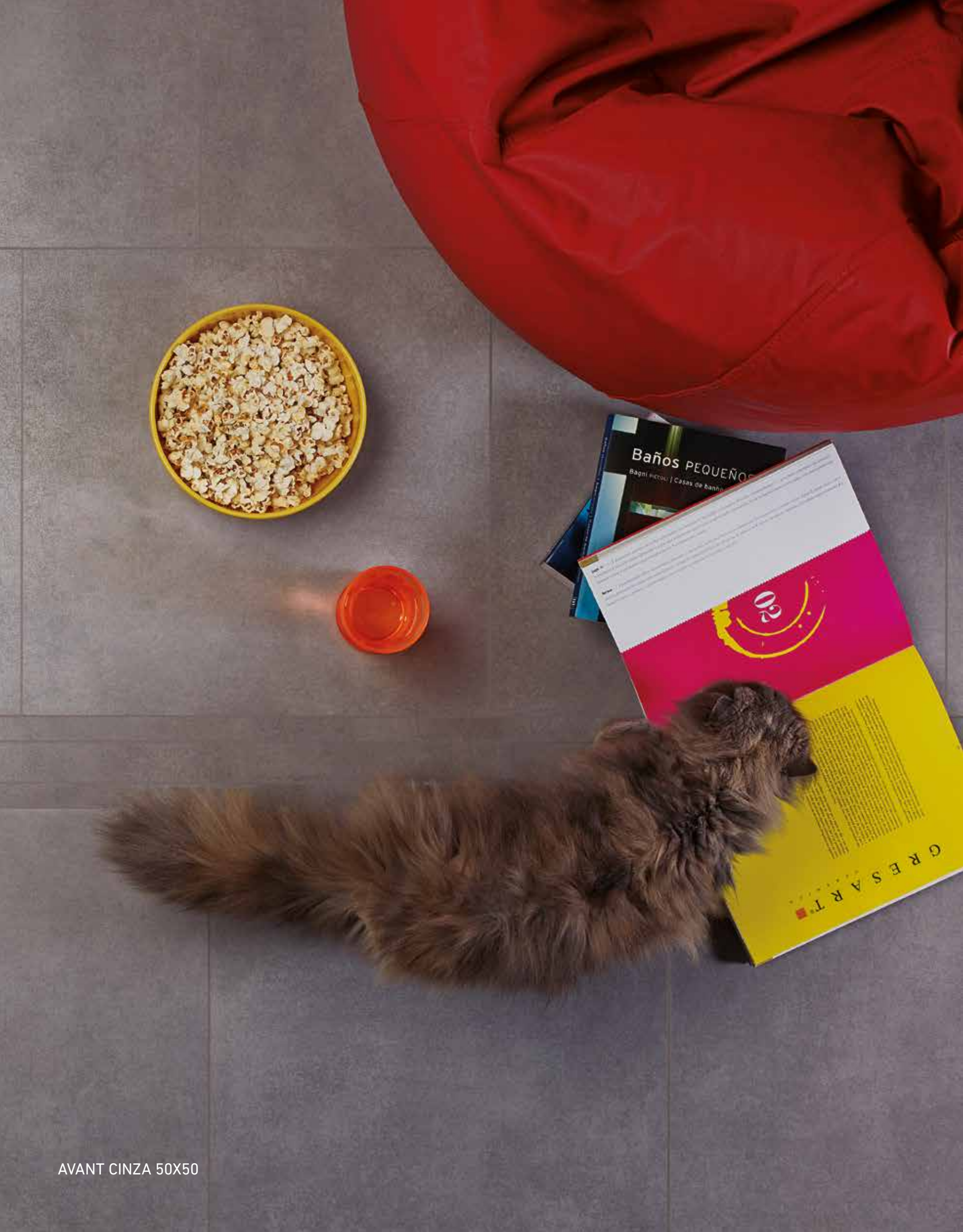

AVANT CINZA 50X50



50X50 / 20"X20"

▼  
9,5 MM  
▲

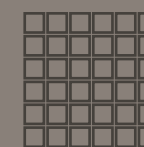

MOSAICO 5,3X5,3  
30X30

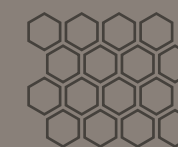

MOSAICO HEXAGONAL  
26X31,5

## USAGE \_USO

WALL, FLOOR, INTERIOR, COMMERCIAL, RESIDENTIAL



AVANT BEGE

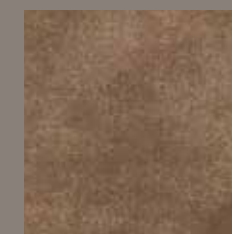

AVANT NOZ



AVANT CINZA

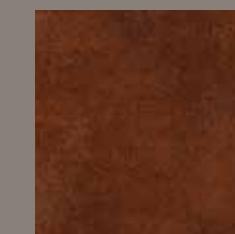

AVANT BRONZE

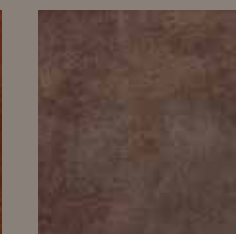

AVANT CASTANHO



AVANT PRETO



# AVANT

GLAZED PORCELAIN TILES \_GRÉS PORCELÂNICO VIDRADO \_GRÈS CÉRAME ÉMAILLÉ  
FEINSTEINZEUG GLASIERT \_GRÉS PORCELÂNICO  
EN 14411:2016 GROUP \_GRUPO \_GROUPE \_GRUPPE Bla



AVANT PRETO 50X50



AVANT BEGE  
GP 0322



AVANT NOZ  
GP 0323



AVANT CINZA  
GP 0321



AVANT BRONZE  
GP 0324



AVANT CASTANHO  
GP 0325



AVANT PRETO  
GP 0326

## SURFACE \_SUPERFÍCIE

MATT SATINE

## FEATURES \_ATRIBUTOS



## FINISH \_ACABAMENTO

NATURAL (NAT)

## SIZES \_FORMATOS

50X50 NAT

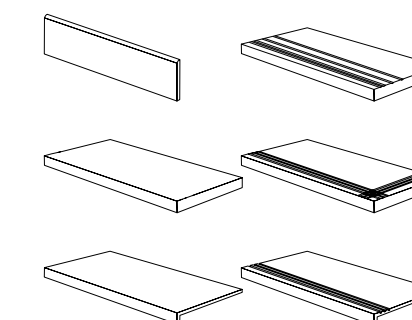

SKIRTINGS \_RODAPÉ 8X50  
STEP \_DEGRAU 50X50  
STEP \_DEGRAU TEC. 30X50



# TERRAZZO

GLAZED PORCELAIN TILES \_GRÉS PORCELÂNICO VIDRADO \_GRÈS CÉRAMÉ ÉMAILLÉ  
FEINSTEINZEUG GLASIERT \_GRÉS PORCELÂNICO  
EN 14411:2016 GROUP \_GRUPO \_GROUPE \_GRUPPE Bla

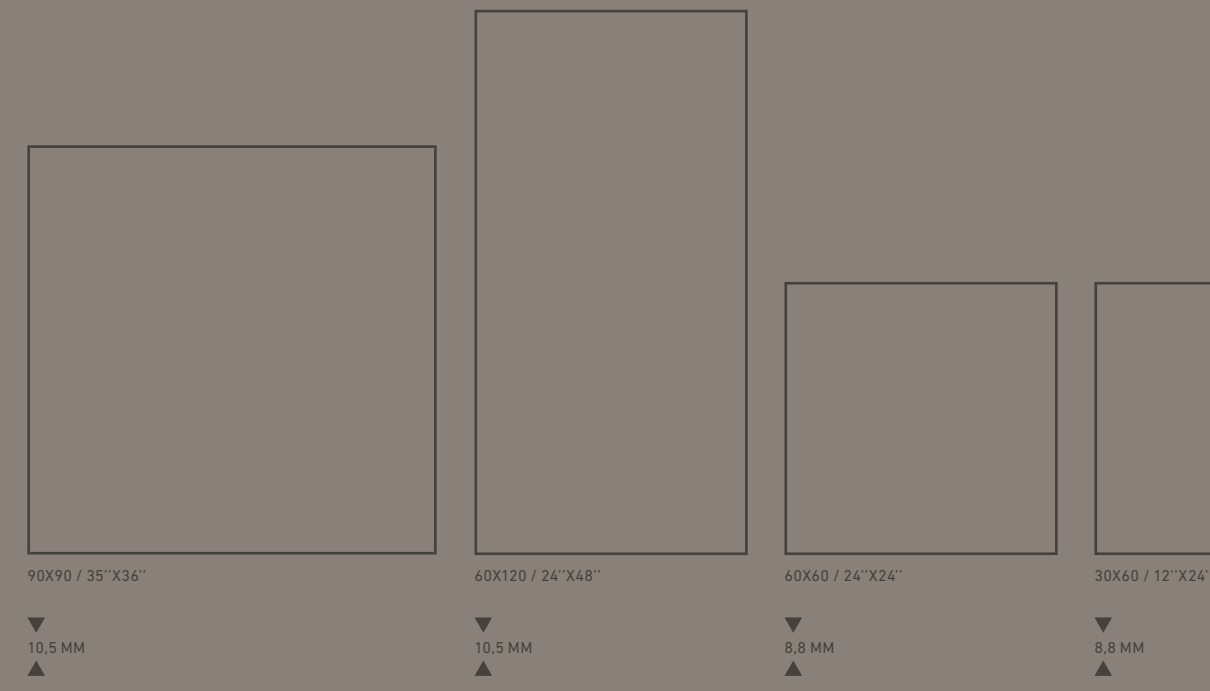

USAGE \_USO  
WALL, FLOOR, INTERIOR, EXTERIOR, COMMERCIAL, RESIDENTIAL



TERRAZZO GREY 60X60 R





TERRAZZO SMOKE 60X60 R  
TERRAZZO TORTORA 60X60 R



# TERRAZZO

 **GLAZED PORCELAIN TILES** \_GRÉS PORCELÂNICO VIDRADO \_GRÈS CÉRAME ÉMAILLÉ  
 **FEINSTEINZEUG GLASIERT** \_GRÉS PORCELÂNICO  
 EN 14411:2016 GROUP \_GRUPO \_GROUPE \_GRUPPE Bla



TERRAZZO GREY 90X90 R

## SURFACE \_SUPERFÍCIE

MATT  
SEMI-POLISHED (SP)

## FEATURES \_ATRIBUTOS

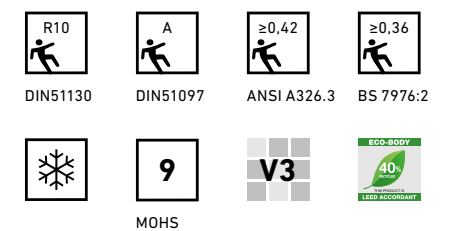

## FINISH \_ACABAMENTO

NATURAL (NAT)  
RECTIFIED (R)

## SIZES \_FORMATOS

90X90 R  
 90X90 SP  
 45X90 R  
 45X90 SP  
 60X120 R  
 60X120 SP  
 60X60 R  
 60X60 SP  
 60X60 NAT  
 30X60 R  
 30X60 SP



TERRAZZO WHITE  
GP 0691

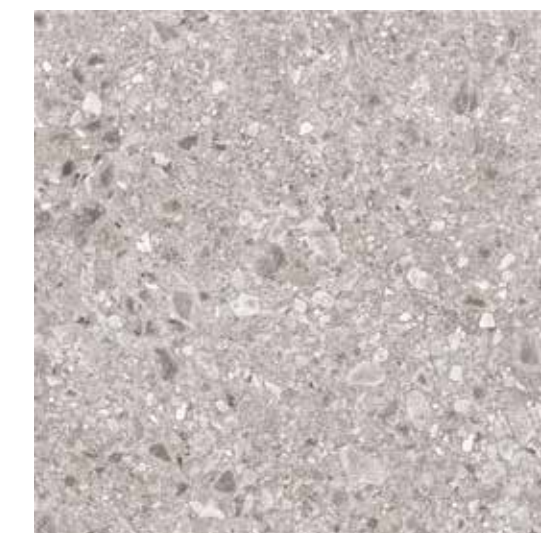

TERRAZZO GREY  
GP 0676

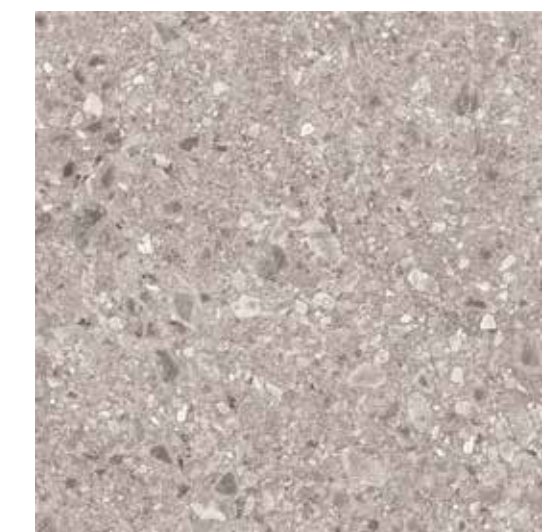

TERRAZZO TORTORA  
GP 0677

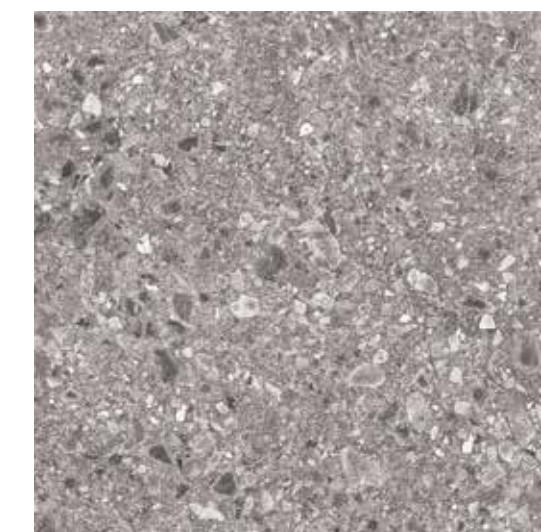

TERRAZZO SMOKE  
GP 0678

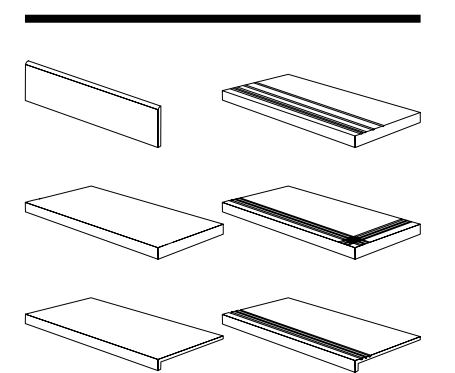

SKIRTINGS \_RODAPÉ 9X90  
 SKIRTINGS \_RODAPÉ 9X120  
 SKIRTINGS \_RODAPÉ 9X60  
 STEP \_DEGRAU 45X90  
 STEP \_DEGRAU 60X120  
 STEP \_DEGRAU 60X60  
 STEP \_DEGRAU TEC. 30X90  
 STEP \_DEGRAU TEC. 30X120  
 STEP \_DEGRAU TEC. 30X60



# BEDROCK

GLAZED PORCELAIN TILES \_GRÉS PORCELÂNICO VIDRADO \_GRÈS CÉRAMÉ ÉMAILLÉ  
FEINSTEINZEUG GLASIERT \_GRÉS PORCELÂNICO  
EN 14411:2016 GROUP \_GRUPO \_GROUPE \_GRUPPE Bla



BEDROCK FOG 90X90 R  
BEDROCK FOG 60X120 R

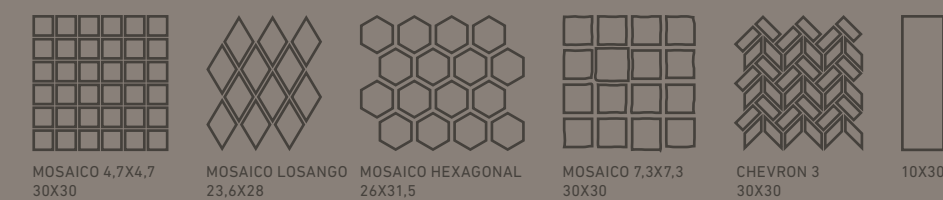
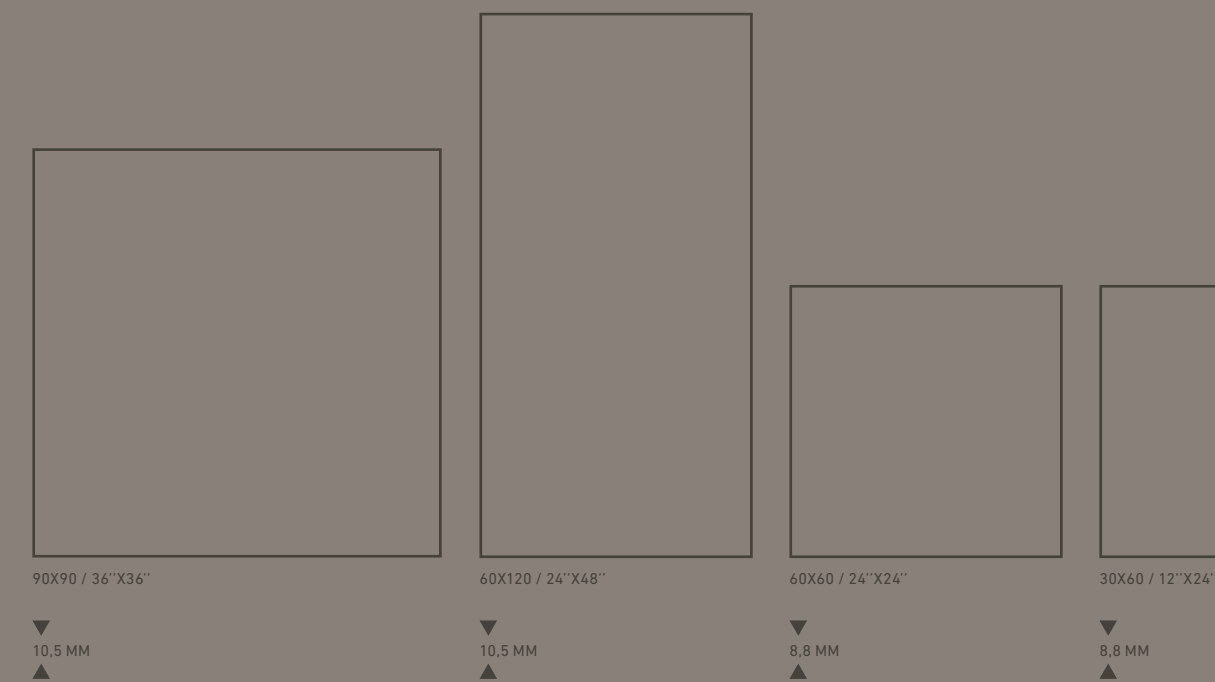

## USAGE\_USO

WALL, FLOOR, INTERIOR, COMMERCIAL, RESIDENTIAL







BEDROCK FOG 60X120 R







# BEDROCK

 **GLAZED PORCELAIN TILES** \_GRÉS PORCELÂNICO VIDRADO \_GRÈS CÉRAME ÉMAILLÉ  
 **FEINSTEINZEUG GLASIERT** \_GRÉS PORCELÂNICO  
 EN 14411:2016 GROUP \_GRUPO \_GROUPE \_GRUPPE Bla



BEDROCK DARK 60X120 R  
VERMONT BROWN 20X120



BEDROCK GOLD  
GP 0693



BEDROCK LIGHT  
GP 0692



BEDROCK SILVER  
GP 0694



BEDROCK FOG  
GP 0695



BEDROCK DARK  
GP 0696

## SURFACE \_SUPERFÍCIE

MATT

## FEATURES \_ATRIBUTOS

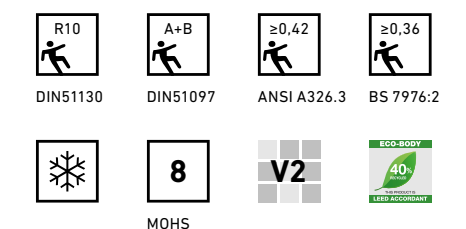

## FINISH \_ACABAMENTO

NATURAL (NAT)  
RECTIFIED (R)

## SIZES \_FORMATOS

90X90 R  
45X90 R  
60X120 R  
60X60 R  
60X60 NAT  
30X60 R  
30X60 NAT

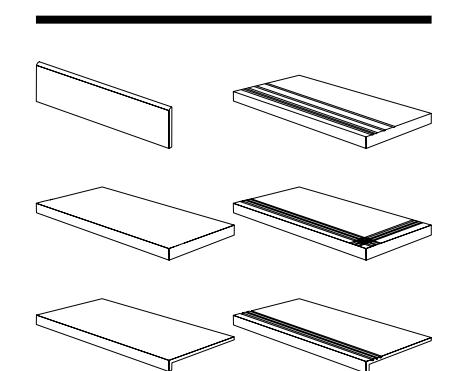

SKIRTINGS \_RODAPÉ 9X90  
SKIRTINGS \_RODAPÉ 9X120  
SKIRTINGS \_RODAPÉ 9X60  
STEP \_DEGRAU 45X90  
STEP \_DEGRAU 60X120  
STEP \_DEGRAU 60X60  
STEP \_DEGRAU TEC. 30X90  
STEP \_DEGRAU TEC. 30X120  
STEP \_DEGRAU TEC. 30X60

BEDROCK



# MOLEANOS

GLAZED PORCELAIN TILES \_GRÉS PORCELÂNICO VIDRADO \_GRÈS CÉRAME ÉMAILLÉ  
FEINSTEINZEUG GLASIERT \_GRÉS PORCELÂNICO  
EN 14411:2016 GROUP \_GRUPO \_GROUPE \_GRUPPE Bla



MOLEANOS CREAM 60X60 R  
MOLEANOS LINES CREAM 30X60  
MOSAICO MOLEANOS CREAM 4,7X4,7



MOLEANOS WHITE  
GP 0525



MOLEANOS LINES WHITE  
GP 0640



MOLEANOS GREY  
GP 0526



MOLEANOS LINES GREY  
GP 0641



MOLEANOS CREAM  
GP 0527



MOLEANOS LINES CREAM  
GP 0642

## SURFACE \_SUPERFÍCIE

MATT  
SEMI-POLISHED (SP)

## FEATURES \_ATRIBUTOS

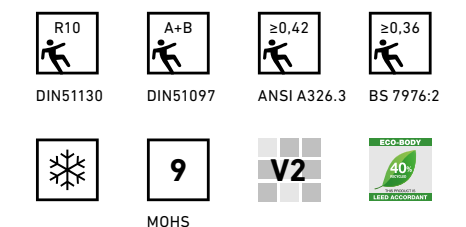

## FINISH \_ACABAMENTO

NATURAL (NAT)  
RECTIFIED (R)

## SIZES \_FORMATOS THICKNESS \_ESPESSURA

60X60 R	8,8 MM
60X60 SP	
60X60 NAT	
30X60 R	8,8 MM
30X60 SP	
30X60 NAT	

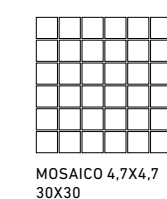
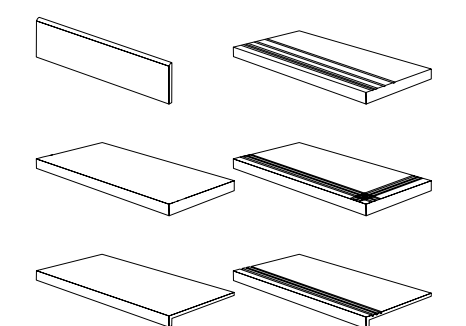

MOSAICO 4,7X4,7  
30X30



MOSAICO LOSANGO  
23,6X28



MOSAICO HEXAGONAL  
26X31,5

SKIRTINGS \_RODAPE 9X60  
STEP \_DEGRAU 60X60  
STEP \_DEGRAU TEC. 30X60



# SANDSTONE

GLAZED PORCELAIN TILES \_GRÉS PORCELÂNICO VIDRADO \_GRÈS CÉRAME ÉMAILLÉ  
FEINSTEINZEUG GLASIERT \_GRÉS PORCELÂNICO  
EN 14411:2016 GROUP \_GRUPO \_GROUPE \_GRUPPE Bla

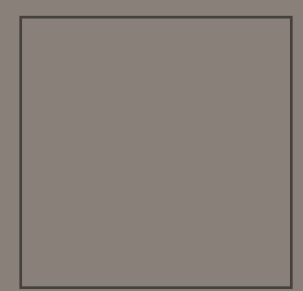

60X60 / 24"X24"

▼  
8,8 MM  
▲



30X60 / 12"X24"

▼  
8,8 MM  
▲



MOSAICO 4,7X4,7  
30X30



MOSAICO LOSANGO  
23,6X28

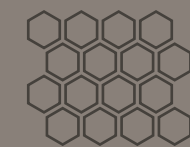

MOSAICO HEXAGONAL  
26X31,5

## USAGE \_USO

WALL, FLOOR, INTERIOR, EXTERIOR, COMMERCIAL, RESIDENTIAL



SANDSTONE ASH



SANDSTONE BONE



SANDSTONE FOG



SANDSTONE SMOKE





SANDSTONE FOG 60X60 R



# SANDSTONE

 **GLAZED PORCELAIN TILES** \_GRÉS PORCELÂNICO VIDRADO \_GRÈS CÉRAME ÉMAILLÉ  
 **FEINSTEINZEUG GLASIERT** \_GRÉS PORCELÂNICO  
 EN 14411:2016 GROUP \_GRUPO \_GROUPE \_GRUPPE Bla



SANDSTONE FOG 60X60



SANDSTONE ASH  
GP 0531



SANDSTONE BONE  
GP 0530



SANDSTONE FOG  
GP 0532



SANDSTONE SMOKE  
GP 0533

## SURFACE \_SUPERFÍCIE

MATT

## FEATURES \_ATRIBUTOS

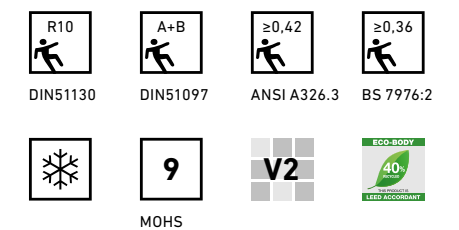

## FINISH \_ACABAMENTO

NATURAL  
RECTIFIED

## SIZES \_FORMATOS

60X60 R  
 60X60 NAT  
 30X60 R  
 30X60 NAT

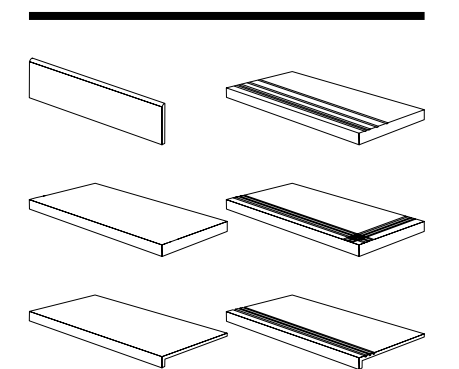

SKIRTINGS \_RODAPÉ 9X60

STEP \_DEGRAU 60X60

STEP \_DEGRAU TEC. 30X60



# SANDSTONE LINES&SQUARES

 **GLAZED PORCELAIN TILES** \_GRÉS PORCELÂNICO VIDRADO \_GRÈS CÉRAME ÉMAILLÉ  
FEINSTEINZEUG GLASIERT \_GRÉS PORCELÁNICO  
EN 14411:2016 GROUP \_GRUPO \_GROUPE \_GRUPPE Bla



LINES LIGHT  
GP 0606



LINES DARK  
GP 0607



SQUARES LIGHT  
GP 0608



SQUARES DARK  
GP 0609

**SURFACE** \_SUPERFÍCIE

MATT

**FEATURES** \_ATRIBUTOS



**FINISH** \_ACABAMENTO

NATURAL (NAT)

**SIZES** \_FORMATOS

30X60 NAT



LINES DARK 30X60  
SANDSTONE FOG 60X60



# ARDÓSIA

GLAZED PORCELAIN TILES \_GRÉS PORCELÂNICO VIDRADO \_GRÈS CÉRAME ÉMAILLÉ  
FEINSTEINZEUG GLASIERT \_GRÉS PORCELÂNICO  
EN 14411:2016 GROUP \_GRUPO \_GROUPE \_GRUPPE Bla

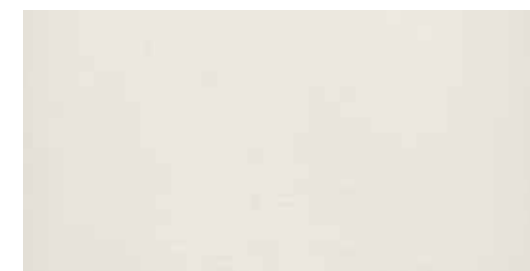

ARDÓSIA PÉROLA  
GP 0231



ARDÓSIA CINZA  
GP 0232



ARDÓSIA PRETO  
GP 0233

## SURFACE \_SUPERFÍCIE

MATT

## FEATURES \_ATRIBUTOS



MOHS

## FINISH \_ACABAMENTO

NATURAL (NAT)

## SIZES \_FORMATOS

### THICKNESS \_ESPESSURA

30X60 NAT	8,7 MM
33X33 NAT	7,8 MM

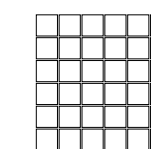
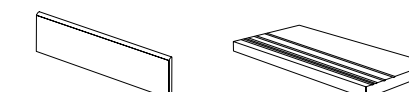

MOSAICO 5,3X5,3  
33X33

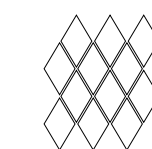

MOSAICO LOSANGO  
23,6X28

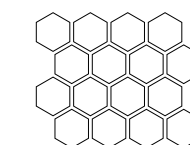

MOSAICO HEXAGONAL  
26X31,5

SKIRTINGS \_RODAPÉ 9X60

SKIRTINGS \_RODAPÉ 8X33

STEP \_DEGRAU 30X60

STEP \_DEGRAU 33X33



# RORIZ

GLAZED PORCELAIN TILES \_GRÉS PORCELÂNICO VIDRADO \_GRÈS CÉRAME ÉMAILLÉ  
FEINSTEINZEUG GLASIERT \_GRÉS PORCELÂNICO  
EN 14411:2016 GROUP \_GRUPO \_GROUPE \_GRUPPE Bla



RORIZ CINZA  
GP 0624



RORIZ BEGE  
GP 0625



RORIZ PRAGAL  
GP 0626

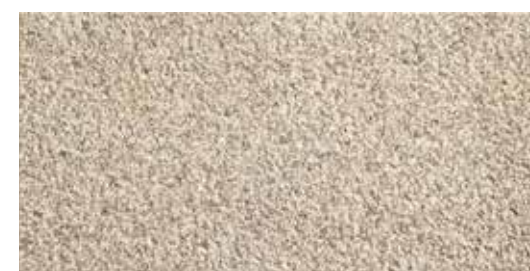

RORIZ REAL  
GP 0627

## SURFACE \_SUPERFÍCIE

MATT ROUGH

## FEATURES \_ATRIBUTOS

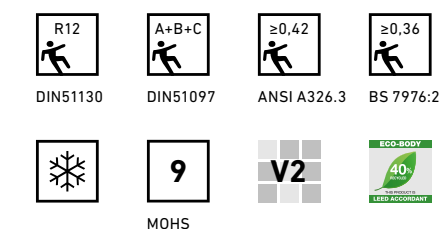

## FINISH \_ACABAMENTO

NATURAL (NAT)

## SIZES \_FORMATOS THICKNESS \_ESPESSURA

30X60 NAT ANTI-SLIP 8,7 MM  
33X33 NAT ANTI-SLIP 7,8 MM

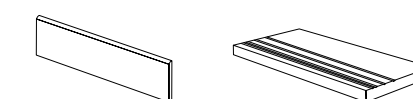

SKIRTINGS \_RODAPÉ 8X33  
STEP \_DEGRAU 33X33



# SLATE

 **GLAZED PORCELAIN TILES** \_GRÉS PORCELÂNICO VIDRADO \_GRÈS CÉRAME ÉMAILLÉ  
 **FEINSTEINZEUG GLASIERT** \_GRÉS PORCELÂNICO  
 EN 14411:2016 GROUP \_GRUPO \_GROUPE \_GRUPPE Bla



SLATE BRANCO  
GP 0365



SLATE PRETO  
GP 0366



SLATE MULTICOLOR  
GP 0367

## SURFACE \_SUPERFÍCIE

MATT

## FEATURES \_ATRIBUTOS

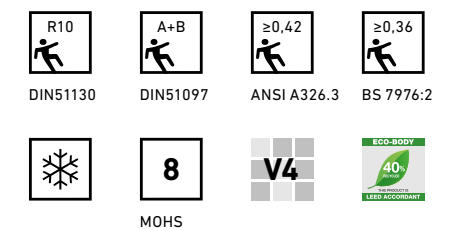

## FINISH \_ACABAMENTO

NATURAL (NAT)

## SIZES \_FORMATOS THICKNESS \_ESPESSURA

30X60 NAT 8,7 MM

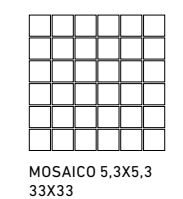
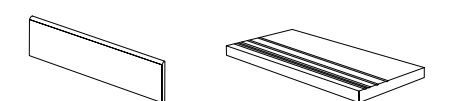

SKIRTINGS \_RODAPE 9X60  
STEP \_DEGRAU 30X60



# BRICK

GLAZED PORCELAIN TILES \_GRÉS PORCELÂNICO VIDRADO \_GRÈS CÉRAME ÉMAILLÉ  
FEINSTEINZEUG GLASIERT \_GRÉS PORCELÁNICO  
EN 14411:2016 GROUP \_GRUPO \_GROUPE \_GRUPPE Bla

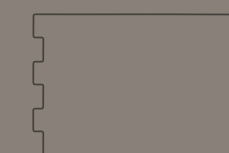

33X47 / 13"18"

▼  
9,5 MM  
▲

USAGE \_USO

WALL, INTERIOR, EXTERIOR, COMMERCIAL, RESIDENTIAL



BRICK BRANCO



BRICK CINZA



BRICK BEGE



BRICK CASTANHO



BRICK PARDO



BRICK PRETO

BRICK BRANCO 33X47  
BETON WHITE 60X60





BRICK PARDO 33X47





BRICK CINZA 33X47

# BRICK

 **GLAZED PORCELAIN TILES** \_GRÉS PORCELÂNICO VIDRADO \_GRÈS CÉRAME ÉMAILLÉ  
FEINSTEINZEUG GLASIERT \_GRÉS PORCELÁNICO  
EN 14411:2016 GROUP \_GRUPO \_GROUPE \_GRUPPE Bla



BRICK BRANCO  
GP 0446



BRICK CINZA  
GP 0447



BRICK BEGE  
GP 0448



BRICK CASTANHO  
GP 0449



BRICK PARDO  
GP 0450



BRICK PRETO  
GP 0451

## SURFACE \_SUPERFÍCIE

MATT

## FEATURES \_ATRIBUTOS



## FINISH \_ACABAMENTO

NATURAL (NAT)

## SIZES \_FORMATOS

33X47 NAT



# LINEA

GLAZED PORCELAIN TILES \_GRÉS PORCELÂNICO VIDRADO \_GRÈS CÉRAME ÉMAILLÉ  
FEINSTEINZEUG GLASIERT \_GRÉS PORCELÂNICO  
EN 14411:2016 GROUP \_GRUPO \_GROUPE \_GRUPPE Bla

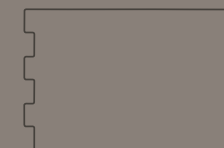

33X47 / 13"18"

▼  
9,5 MM  
▲

## USAGE \_USO

WALL, INTERIOR, EXTERIOR, COMMERCIAL, RESIDENTIAL



LINEA CINZA



LINEA BEGE



LINEA MIX CINZA



LINEA MIX BEGE



LINEA MULTICOLOR





LINEA MIX BEGE 33X47

# LINEA

 **GLAZED PORCELAIN TILES** \_GRÉS PORCELÂNICO VIDRADO \_GRÈS CÉRAME ÉMAILLÉ  
FEINSTEINZEUG GLASIERT \_GRÉS PORCELÂNICO  
EN 14411:2016 GROUP \_GRUPO \_GROUPE \_GRUPPE Bla



LINEA CINZA  
GP 0461



LINEA BEGE  
GP 0462



LINEA MIX CINZA  
GP 0463



LINEA MIX BEGE  
GP 0464



LINEA MULTICOLOR  
GP 0469

**SURFACE** \_SUPERFÍCIE

MATT

**FEATURES** \_ATRIBUTOS



**FINISH** \_ACABAMENTO

NATURAL (NAT)

**SIZES** \_FORMATOS

33X47 NAT



# LINEA VINTAGE\_CLASSIC

GLAZED PORCELAIN TILES \_GRÉS PORCELÂNICO VIDRADO \_GRÈS CÉRAME ÉMAILLÉ  
FEINSTEINZEUG GLASIERT \_GRÉS PORCELÁNICO  
EN 14411:2016 GROUP \_GRUPO \_GROUPE \_GRUPPE Bla



33X47 / 13"18"

▼  
9,5 MM  
▲

USAGE \_USO

WALL, INTERIOR, EXTERIOR, COMMERCIAL, RESIDENTIAL

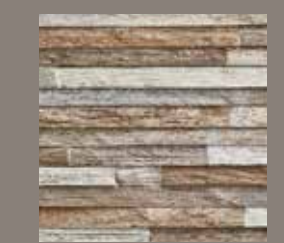

LINEA VINTAGE

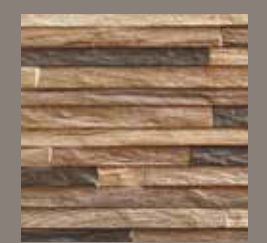

LINEA CLASSIC

LINEA VINTAGE 33X47  
VINTAGE MULTICOLOR 15X60



ception



BRICK BEGE 33X47  
LINEA CLASSIC 33X47

# LINEA VINTAGE\_CLASSIC

 **GLAZED PORCELAIN TILES** \_GRÉS PORCELÂNICO VIDRADO \_GRÈS CÉRAMÉ ÉMAILLÉ  
FEINSTEINZEUG GLASIERT \_GRÉS PORCELÁNICO  
EN 14411:2016 GROUP \_GRUPO \_GROUPE \_GRUPPE Bla



LINEA VINTAGE  
GP 0465



LINEA CLASSIC  
GP 0466

**SURFACE** \_SUPERFÍCIE

MATT

**FEATURES** \_ATRIBUTOS



**FINISH** \_ACABAMENTO

NATURAL (NAT)

**SIZES** \_FORMATOS

33X47 NAT



# COTTO

GLAZED PORCELAIN TILES \_GRÉS PORCELÂNICO VIDRADO \_GRÈS CÉRAMÉ ÉMAILLÉ  
FEINSTEINZEUG GLASIERT \_GRÉS PORCELÂNICO  
EN 14411:2016 GROUP \_GRUPO \_GROUPE \_GRUPPE Bla



33X33 / 13"X13"

▼  
7,8 MM  
▲

## USAGE \_USO

WALL, FLOOR, INTERIOR, COMMERCIAL, RESIDENTIAL / EXTERIOR ONLY ANTI-SLIP



COTTO GREY



COTTO BEGE



COTTO BROWN







# COTTO

GLAZED PORCELAIN TILES \_GRÉS PORCELÂNICO VIDRADO \_GRÈS CÉRAME ÉMAILLÉ  
FEINSTEINZEUG GLASIERT \_GRÉS PORCELÁNICO  
EN 14411:2016 GROUP \_GRUPO \_GROUPE \_GRUPPE Bla



COTTO BEGE 33X33



COTTO GREY  
GP 0505

COTTO GREY ANTI-SLIP  
GP 0508



COTTO BEGE  
GP 0506

COTTO BEGE ANTI-SLIP  
GP 0509



COTTO BROWN  
GP 0507

COTTO BROWN ANTI-SLIP  
GP 0510

## SURFACE \_SUPERFÍCIE

MATT

## FEATURES \_ATRIBUTOS

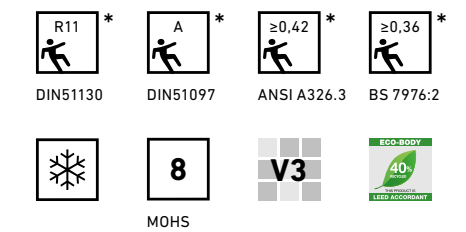

## FINISH \_ACABAMENTO

NATURAL (NAT)

## SIZES \_FORMATOS

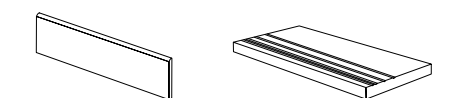

33X33 NAT  
33X33 NAT ANTI-SLIP\*



SKIRTINGS \_RODAPÉ 8X3  
STEP \_DEGRAU 33X33



# MIX&MATCH

 **GLAZED PORCELAIN TILES** \_GRÉS PORCELÂNICO VIDRADO \_GRÈS CÉRAMÉ ÉMAILLÉ  
 **FEINSTEINZEUG GLASIERT** \_GRÉS PORCELÂNICO  
 EN 14411:2016 GROUP \_GRUPO \_GROUPE \_GRUPPE **Bl**



MIX&MATCH CREAM 60X60 R



60X60 / 24"X24"

30X60 / 12"X24"

▼  
8,8 MM  
▲

▼  
8,8 MM  
▲

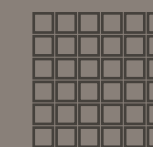

MOSAICO 4,7X4,7  
30X30



MOSAICO LOSANGO  
23,6X28

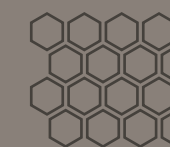

MOSAICO HEXAGONAL  
26X31,5

## USAGE \_USO

WALL, FLOOR, INTERIOR, COMMERCIAL, RESIDENTIAL

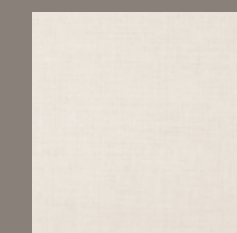

MIX&MATCH WHITE



MIX&MATCH CREAM



MIX&MATCH GREY

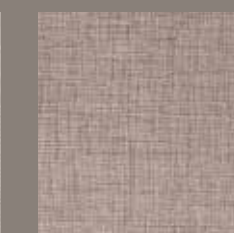

MIX&MATCH TORTORA

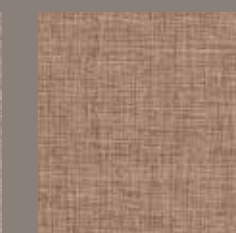

MIX&MATCH BROWN







# MIX&MATCH

GLAZED PORCELAIN TILES \_GRÉS PORCELÂNICO VIDRADO \_GRÈS CÉRAME ÉMAILLÉ  
FEINSTEINZEUG GLASIERT \_GRÉS PORCELÂNICO  
EN 14411:2016 GROUP \_GRUPO \_GROUPE \_GRUPPE Bla

## SURFACE \_SUPERFÍCIE

MATT

## FEATURES \_ATRIBUTOS



## FINISH \_ACABAMENTO

NATURAL (NAT)  
RECTIFIED (R)

## SIZES \_FORMATOS

60X60 R  
60X60 NAT  
30X60 R

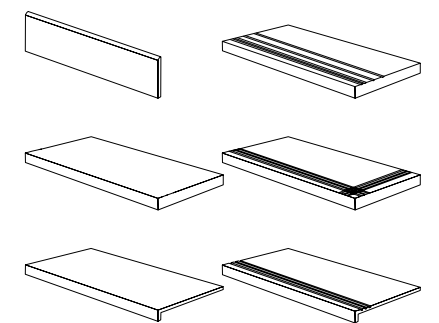

SKIRTINGS \_RODAPÉ 9X60  
STEP \_DEGRAU 60X60  
STEP \_DEGRAU TEC. 30X60



MIX&MATCH WHITE  
GP 0585



MIX&MATCH CREAM  
GP 0605



MIX&MATCH GREY  
GP 0586



MIX&MATCH TORTORA  
GP 0587



MIX&MATCH BROWN  
GP 0588



MIX&MATCH DECOR  
GP 0589



MIX&MATCH SQUARE MIX  
GP 0590



MIX&MATCH DECOR 30X60 R



# MIX&MATCH

 **WHITE BODY WALL TILES** \_REVESTIMENTOS EM PASTA BRANCA \_CARREAUX DE MUR EN PATE BLANCHE  
WEISSEN TON WANDFLIESEN \_REVESTIMIENTOS EN PASTA BLANCA  
EN 14411:2016 GROUP \_GRUPO \_GROUPE \_GRUPPE BIII



MIX&MATCH WHITE  
GM 0585



MIX&MATCH DECOR BIRDS WHITE  
GM 0610



MIX&MATCH CREAM  
GM 0605



MIX&MATCH DECOR BIRDS CREAM  
GM 0614



MIX&MATCH GREY  
GM 0586



MIX&MATCH DECOR BIRDS GREY  
GM 0611



MIX&MATCH TORTORA  
GM 0587



MIX&MATCH DECOR BIRDS TORTORA  
GM 0612



MIX&MATCH BROWN  
GM 0588



MIX&MATCH DECOR BIRDS BROWN  
GM 0613

**SURFACE** \_SUPERFÍCIE

MATT

**FEATURES** \_ATRIBUTOS



**FINISH** \_ACABAMENTO

NATURAL (NAT)  
RECTIFIED (R)



**SIZES** \_FORMATOS

30X60 R  
30X60 NAT

MIX&MATCH DECOR BIRDS WHITE 30X60  
MIX&MATCH GREY 60X60



# METALLICA

 **GLAZED PORCELAIN TILES** \_GRÉS PORCELÂNICO VIDRADO \_GRÈS CÉRAMÉ ÉMAILLÉ  
 **FEINSTEINZEUG GLASIERT** \_GRÉS PORCELÂNICO  
 EN 14411:2016 GROUP \_GRUPO \_GROUPE \_GRUPPE **Bl**a

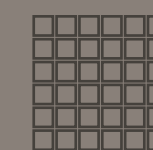
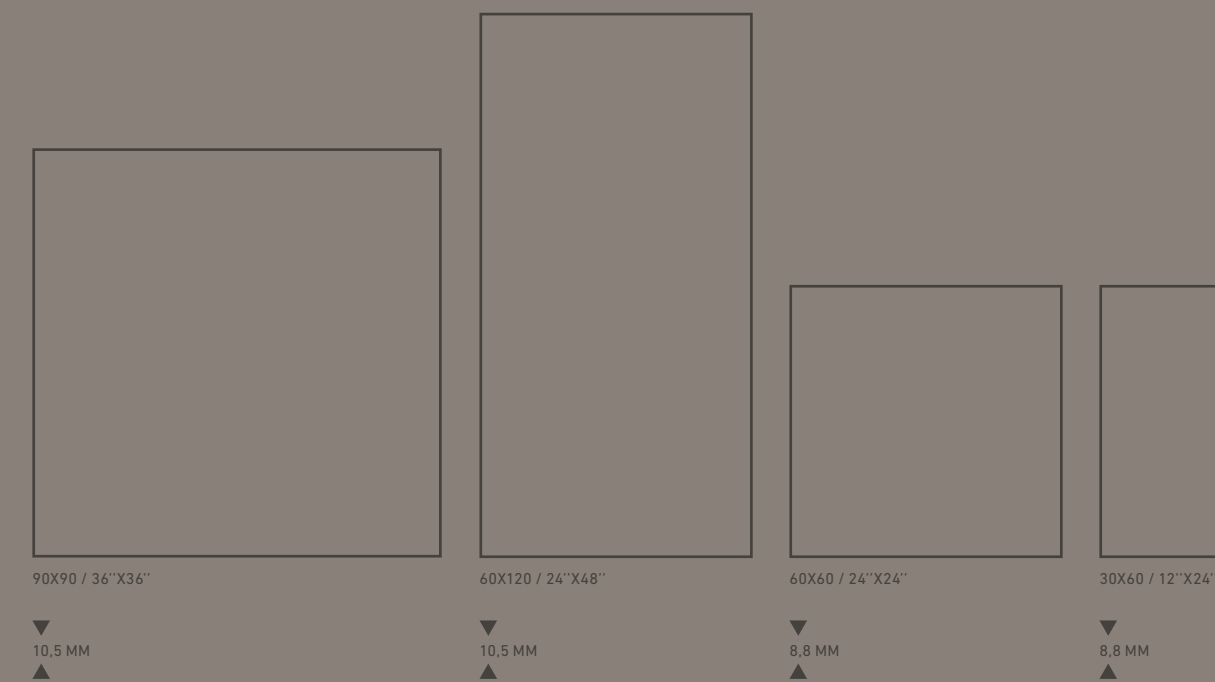

MOSAICO 4,7X4,7  
30X30



MOSAICO LOSANGO  
23,6X28



MOSAICO HEXAGONAL  
26X31,5

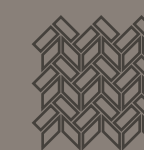

CHEVRON 3  
30X30

## USAGE \_USO

WALL, FLOOR, INTERIOR, COMMERCIAL, RESIDENTIAL



METALLICA WHITE



METALLICA SILVER



METALLICA TITAN



METALLICA OXYD



METALLICA DARK

METALLICA TITAN 60X120  
METALLICA TITAN 90X90





THE  
HOTEL

METALLICA TITAN 60X120  
METALLICA SILVER 60X120  
METALLICA SILVER 90X90



# METALLICA

GLAZED PORCELAIN TILES \_GRÉS PORCELÂNICO VIDRADO \_GRÈS CÉRAME ÉMAILLÉ  
FEINSTEINZEUG GLASIERT \_GRÉS PORCELÂNICO  
EN 14411:2016 GROUP \_GRUPO \_GROUPE \_GRUPPE Bla



METALLICA DECOR WHITE  
GP 0714



METALLICA DECOR SILVER  
GP 0715



METALLICA DECOR TITAN  
GP 0716



METALLICA DECOR OXYD  
GP 0717



METALLICA DARK  
GP 0718

# METALLICA

GLAZED PORCELAIN TILES \_GRÉS PORCELÂNICO VIDRADO \_GRÈS CÉRAME ÉMAILLÉ  
FEINSTEINZEUG GLASIERT \_GRÉS PORCELÂNICO  
EN 14411:2016 GROUP \_GRUPO \_GROUPE \_GRUPPE Bla



METALLICA WHITE  
GP 0671



METALLICA SILVER  
GP 0672



METALLICA TITAN  
GP 0673



METALLICA OXYD  
GP 0674



METALLICA DARK  
GP 0675

## SURFACE \_SUPERFÍCIE

MATT  
SEMI-POLISHED (SP)

## FEATURES \_ATRIBUTOS

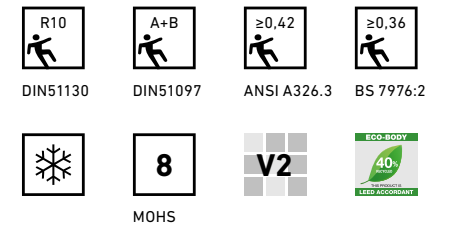

## FINISH \_ACABAMENTO

NATURAL (NAT)  
RECTIFIED (R)

## SIZES \_FORMATOS

90X90 R  
90X90 SP  
45X90 R  
45X90 SP  
60X120 R  
60X120 SP  
60X60 R  
60X60 SP  
60X60 NAT  
30X60 R  
30X60 SP

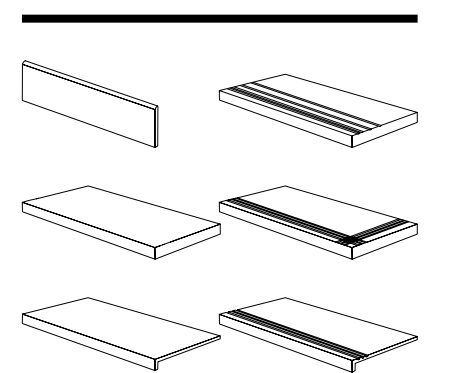

SKIRTINGS \_RODAPÉ 9X90  
SKIRTINGS \_RODAPÉ 9X120  
SKIRTINGS \_RODAPÉ 9X60  
STEP \_DEGRAU 45X90  
STEP \_DEGRAU 60X120  
STEP \_DEGRAU 60X60  
STEP \_DEGRAU TEC. 30X90  
STEP \_DEGRAU TEC. 30X120  
STEP \_DEGRAU TEC. 30X60

METALLICA





METALLICA WHITE 30X90  
METALLICA WHITE LINES 30X90  
METALLICA TITAN QUADRI 30X90  
METALLICA TITAN 90X90



# METALLICA

 **WHITE BODY WALL TILES** \_REVESTIMENTOS EM PASTA BRANCA \_CARREAUX DE MUR EN PATE BLANCHE  
WEISSEN TON WANDFLIESEN \_REVESTIMIENTOS EN PASTA BLANCA  
EN 14411:2016 GROUP \_GRUPO \_GROUPE \_GRUPPE BIII



METALLICA WHITE  
GM 0671



METALLICA SILVER  
GM 0672



METALLICA TITAN  
GM 0673



METALLICA OXYD  
GM 0674



METALLICA DARK  
GM 0675

## SURFACE \_SUPERFÍCIE

MATT

## FEATURES \_ATRIBUTOS



## FINISH \_ACABAMENTO

NATURAL (NAT)  
RECTIFIED (R)

## SIZES \_FORMATOS THICKNESS \_ESPESSURA

30X90 R	10,5 MM
30X90 NAT	
30X60 R	9,5 MM
30X60 NAT	



METALLICA TITAN 60X120 SP



# METALLICA

 **WHITE BODY WALL TILES** \_REVESTIMENTOS EM PASTA BRANCA \_CARREAUX DE MUR EN PATE BLANCHE  
WEISSEN TON WANDFLIESEN \_REVESTIMENTOS EN PASTA BLANCA  
EN 14411:2016 GROUP \_GRUPO \_GROUPE \_GRUPPE BIII



METALLICA WHITE QUADRI  
GM 0751



METALLICA WHITE LINES  
GM 0756



METALLICA SILVER QUADRI  
GM 0752



METALLICA SILVER LINES  
GM 0757



METALLICA TITAN QUADRI  
GM 0753



METALLICA TITAN LINES  
GM 0758



METALLICA OXYD QUADRI  
GM 0754



METALLICA OXYD LINES  
GM 0759



METALLICA DARK QUADRI  
GM 0755



METALLICA DARK LINES  
GM 0760

**SURFACE** \_SUPERFÍCIE

MATT

**FEATURES** \_ATRIBUTOS



**FINISH** \_ACABAMENTO

NATURAL (NAT)  
RECTIFIED (R)

**SIZES** \_FORMATOS  
**THICKNESS** \_ESPESSURA

30X90 R	10,5 MM
30X60 NAT	9,5 MM



# METALLICA

 **WHITE BODY WALL TILES** \_REVESTIMENTOS EM PASTA BRANCA \_CARREAUX DE MUR EN PATE BLANCHE  
WEISSEN TON WANDFLIESEN \_REVESTIMENTOS EN PASTA BLANCA  
EN 14411:2016 GROUP \_GRUPO \_GROUPE \_GRUPPE BIII



METALLICA WHITE  
MOSAICO 4,7X4,7  
30X30



METALLICA SILVER  
MOSAICO 4,7X4,7  
30X30

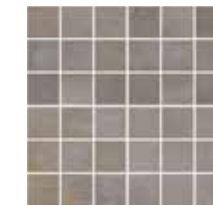

METALLICA TITAN  
MOSAICO 4,7X4,7  
30X30

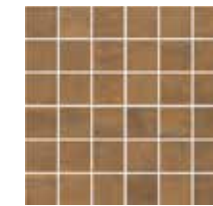

METALLICA OXYD  
MOSAICO 4,7X4,7  
30X30

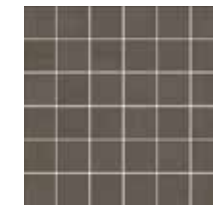

METALLICA DARK  
MOSAICO 4,7X4,7  
30X30

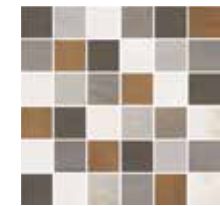

METALLICA MIX  
MOSAICO 4,7X4,7  
30X30



METALLICA WHITE  
CHEVRON 3  
30X30



METALLICA SILVER  
CHEVRON 3  
30X30



METALLICA TITAN  
CHEVRON 3  
30X30



METALLICA OXYD  
CHEVRON 3  
30X30



METALLICA DARK  
CHEVRON 3  
30X30



METALLICA MIX  
CHEVRON 3  
30X30



METALLICA WHITE  
MOSAICO LOSANGO  
23,6X28



METALLICA SILVER  
MOSAICO LOSANGO  
23,6X28



METALLICA TITAN  
MOSAICO LOSANGO  
23,6X28



METALLICA OXYD  
MOSAICO LOSANGO  
23,6X28



METALLICA DARK  
MOSAICO LOSANGO  
23,6X28





METALLICA MIX  
MOSAICO LOSANGO  
23,6X28



METALLICA TITAN 60X120 SP



# GAME OF STONES

 GLAZED PORCELAIN TILES \_GRÉS PORCELÂNICO VIDRADO \_GRÈS CÉRAME ÉMAILLÉ  
 FEINSTEINZEUG GLASIERT \_GRÉS PORCELÂNICO  
 EN 14411:2016 GROUP \_GRUPO \_GROUPE \_GRUPPE **Bl**

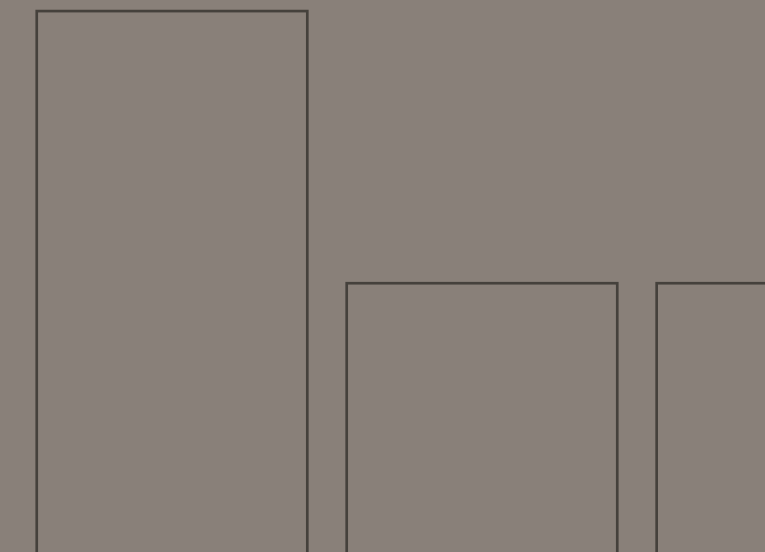

60X120 / 24"X48"      60X60 / 24"X24"      30X60 / 12"X24"

▼ 10,5 MM      ▼ 8,8 MM      ▼ 8,8 MM  
▲ ▲ ▲



MOSAICO 4,7X4,7 30X30      MOSAICO LOSANGO 23,6X28      MOSAICO HEXAGONAL 26X31,5

## USAGE \_USO

WALL, FLOOR, INTERIOR, COMMERCIAL, RESIDENTIAL



STATUARIO      GREY STONE      CREMA MARFIL      CARRARA





STATUARIO 60X60 R  
STATUARIO 30X90 R





GREYSTONE 60X60



# GAME OF STONES

GLAZED PORCELAIN TILES \_GRÉS PORCELÂNICO VIDRADO \_GRÈS CÉRAME ÉMAILLÉ  
FEINSTEINZEUG GLASIERT \_GRÉS PORCELÂNICO  
EN 14411:2016 GROUP \_GRUPO \_GROUPE \_GRUPPE Bla



CREMA MARFIL 60X60



STATUARIO  
GP 0745



GREYSTONE  
GP 0746



CREMA MARFIL  
GP 0382



CARRARA  
GP 0384

## SURFACE \_SUPERFÍCIE

GLOSSY

## FEATURES \_ATRIBUTOS



## FINISH \_ACABAMENTO

NATURAL (NAT)  
RECTIFIED (R)

## SIZES \_FORMATOS

60X120 R  
60X60 R  
60X60 NAT  
30X60 R





STATUARIO LINES 30X90 R  
STATUARIO 60X60 R





GREYSTONE 30X90 R  
GREYSTONE LINES 30X90 R



# GAME OF STONES

 **WHITE BODY WALL TILES** \_REVESTIMENTOS EM PASTA BRANCA \_CARREAUX DE MUR EN PATE BLANCHE  
WEISSEN TON WANDFLIESEN \_REVESTIMIENTOS EN PASTA BLANCA  
EN 14411:2016 GROUP \_GRUPO \_GROUPE \_GRUPPE BIII



STATUARIO  
GM 0745



GREYSTONE  
GM 0746



STATUARIO LINES  
GM 0767



GREYSTONE LINES  
GM 0768



STATUARIO SQUARES  
GM 0763



GREYSTONE SQUARES  
GM 0764



STATUARIO  
MOSAICO ENTRELAÇADO  
33X35



STATUARIO  
MOSAICO HEXAGONAL  
26X31,5



STATUARIO  
MOSAICO 4,7X4,7  
30X30



GREYSTONE  
MOSAICO ENTRELAÇADO  
33X35



GREYSTONE  
MOSAICO HEXAGONAL  
26X31,5

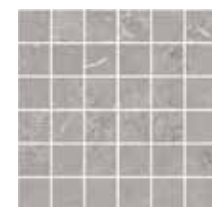

GREYSTONE  
MOSAICO 4,7X4,7  
30X30

# GAME OF STONES

 **WHITE BODY WALL TILES** \_REVESTIMENTOS EM PASTA BRANCA \_CARREAUX DE MUR EN PATE BLANCHE  
WEISSEN TON WANDFLIESEN \_REVESTIMIENTOS EN PASTA BLANCA  
EN 14411:2016 GROUP \_GRUPO \_GROUPE \_GRUPPE BIII



CREMA MARFIL  
GM 0382



CARRARA  
GM 0384



CREMA MARFIL LINES  
GM 0765



CARRARA LINES  
GM 0766



CREMA MARFIL SQUARES  
GM 0761



CARRARA SQUARES  
GM 0762



CREMA MARFIL  
MOSAICO ENTRELAÇADO  
33X35



CREMA MARFIL  
MOSAICO HEXAGONAL  
26X31,5



CREMA MARFIL  
MOSAICO 4,7X4,7  
30X30



CARRARA  
MOSAICO ENTRELAÇADO  
33X35



CARRARA  
MOSAICO HEXAGONAL  
26X31,5



CARRARA  
MOSAICO 4,7X4,7  
30X30

**SURFACE** \_SUPERFÍCIE

GLOSSY

**FINISH** \_ACABAMENTO

NATURAL (NAT)  
RECTIFIED (R)

**SIZES** \_FORMATOS

**THICKNESS** \_ESPESSURA

30X90 R  
30X60 R  
30X60 NAT

10,5 MM  
9,5 MM



# NEO

 **WHITE BODY WALL TILES** \_REVESTIMENTOS EM PASTA BRANCA \_CARREAUX DE MUR EN PATE BLANCHE  
WEISSEN TON WANDFLIESEN \_REVESTIMIENTOS EN PASTA BLANCA  
EN 14411:2016 GROUP \_GRUPO \_GROUPE \_GRUPPE BIII



NEO LINES MIX BEGE 30X90

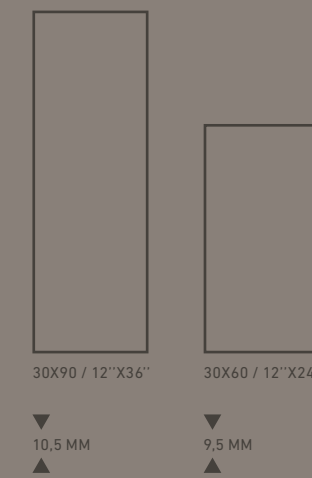

## USAGE \_USO

INTERIOR, COMMERCIAL, RESIDENTIAL







NEO LINES MIX GRUN BLAU 30X60  
NEO POWDER 30X90  
NEO BLUE 30X90  
OAK WHITE 20X120





NEO GREEN 30X90  
OAK DARK 20X120



# NEO

**WHITE BODY WALL TILES** \_REVESTIMENTOS EM PASTA BRANCA \_CARREAUX DE MUR EN PATE BLANCHE  
WEISSEN TON WANDFLIESEN \_REVESTIMIENTOS EN PASTA BLANCA  
EN 14411:2016 GROUP \_GRUPO \_GROUPE \_GRUPPE BIII

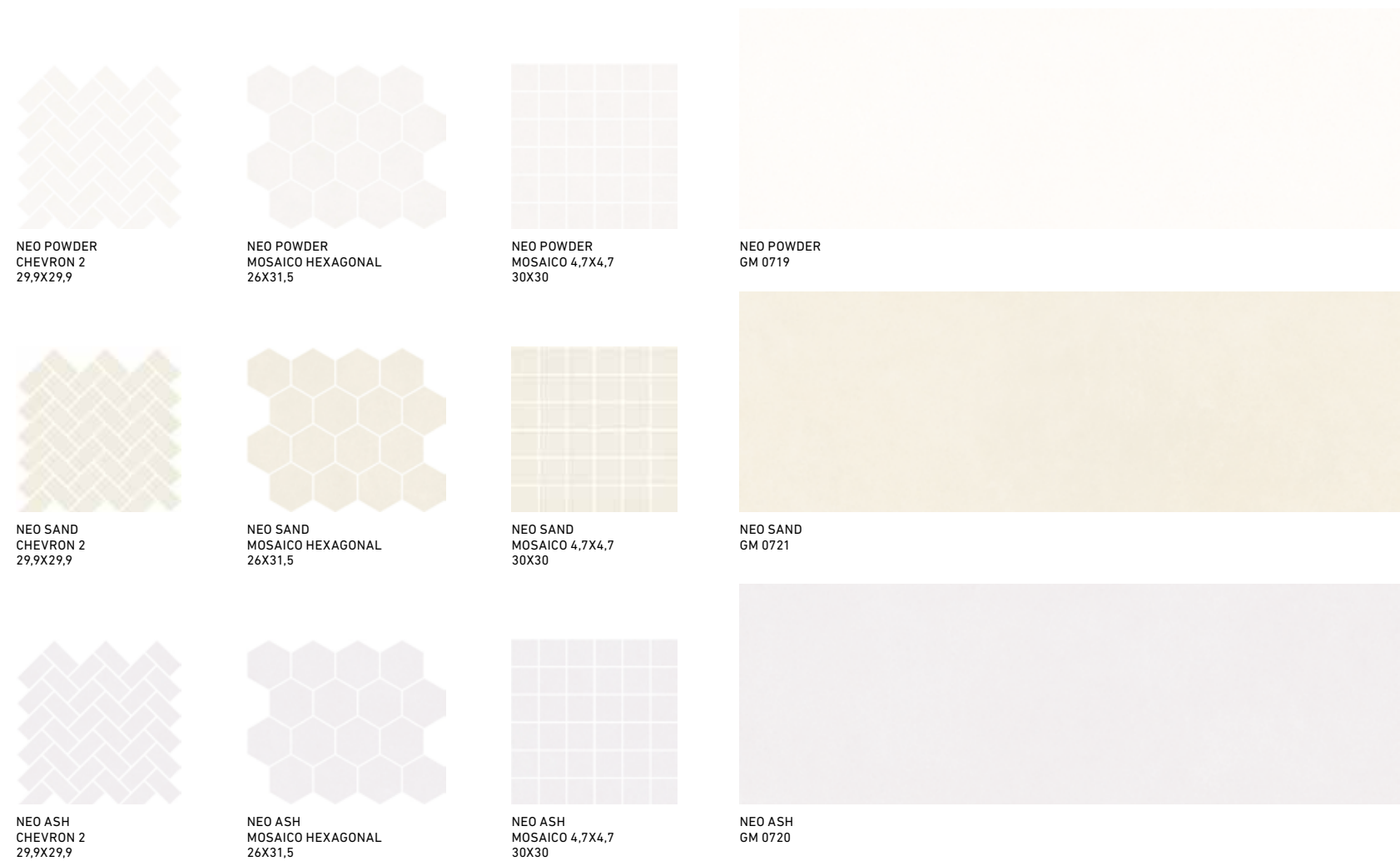

## RECOMMENDED CERAMIC TILES COMBINATION \_COMBINAÇÃO CERÂMICA RECOMENDADA



# NEO

**WHITE BODY WALL TILES** \_REVESTIMENTOS EM PASTA BRANCA \_CARREAUX DE MUR EN PATE BLANCHE  
WEISSEN TON WANDFLIESEN \_REVESTIMIENTOS EN PASTA BLANCA  
EN 14411:2016 GROUP \_GRUPO \_GROUPE \_GRUPPE BIII

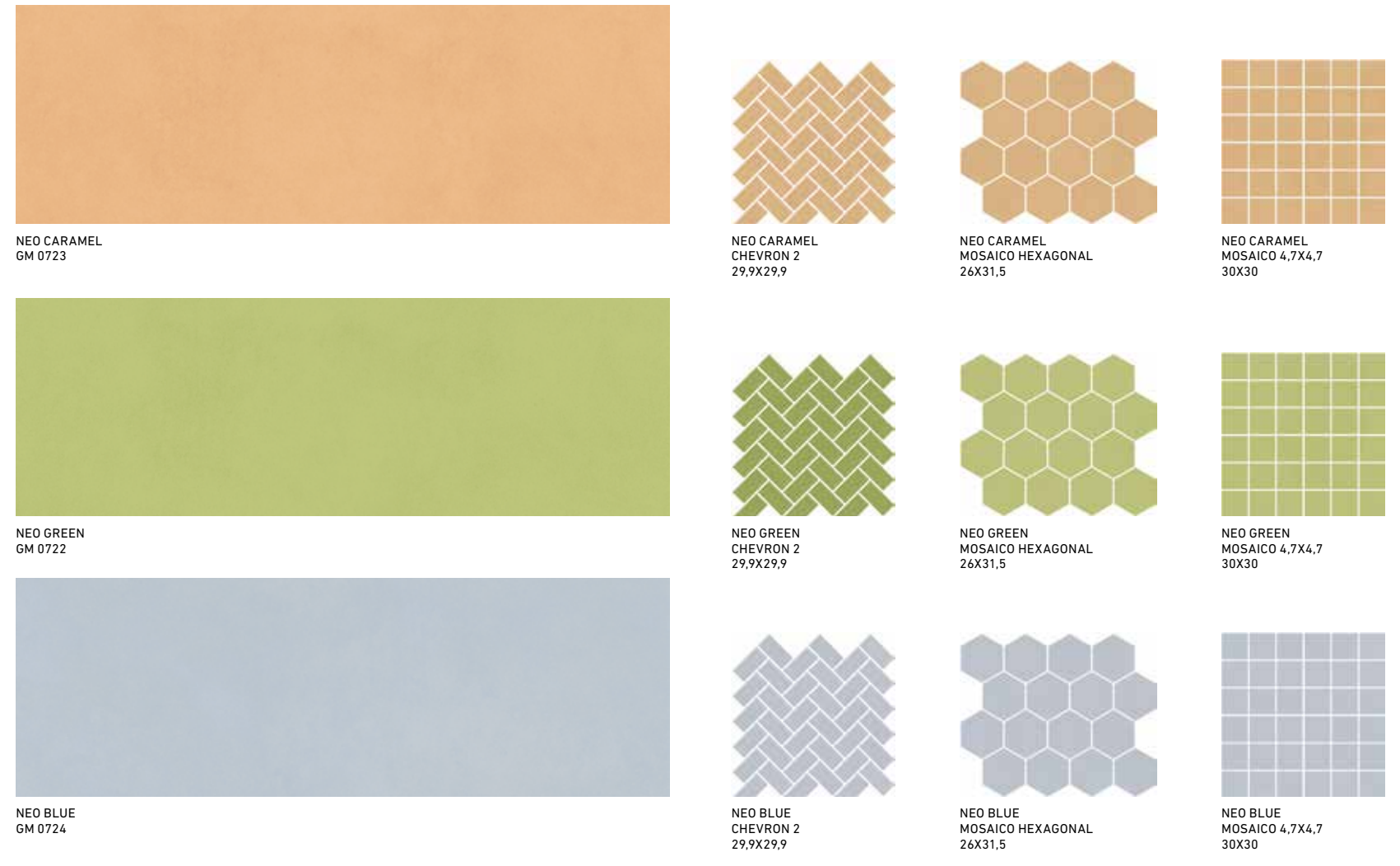

## RECOMMENDED CERAMIC TILES COMBINATION \_COMBINAÇÃO CERÂMICA RECOMENDADA

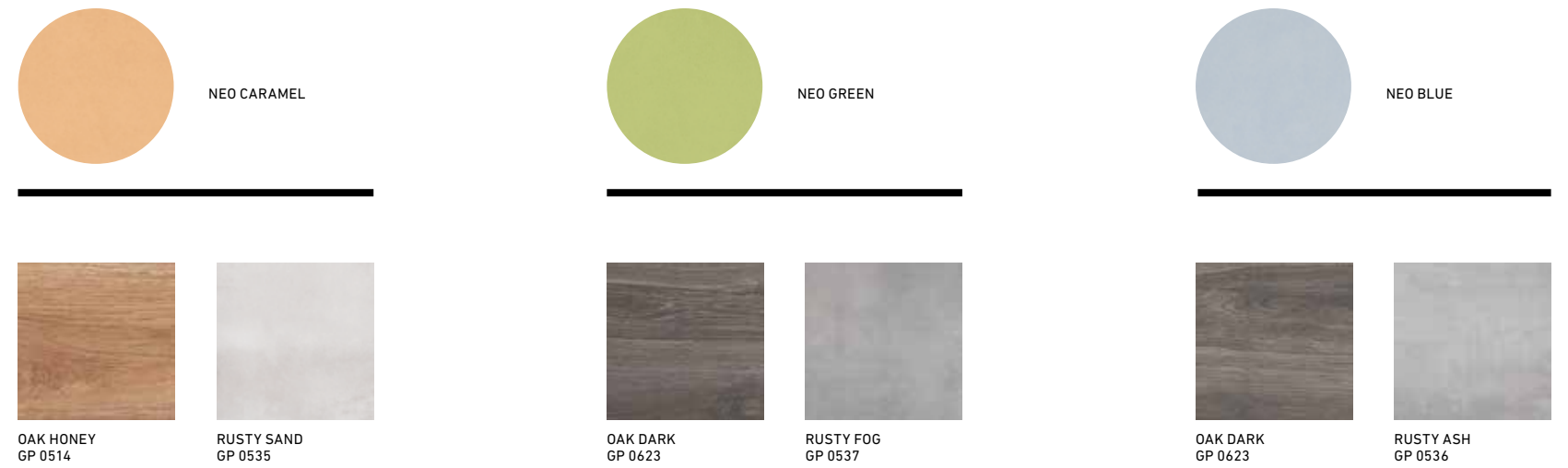

SURFACE _SUPERFÍCIE	FINISH _ACABAMENTO	SIZES _FORMATOS THICKNESS _ESPESSURA	
MATT	NATURAL (NAT)	30X90 R	10,5 MM
		30X90 NAT	
	RECTIFIED (R)	30X60 R	9,5 MM
		30X60 NAT	



# NEO

**WHITE BODY WALL TILES** \_REVESTIMENTOS EM PASTA BRANCA \_CARREAUX DE MUR EN PATE BLANCHE  
 WEISSEN TON WANDFLIESEN \_REVESTIMIENTOS EN PASTA BLANCA  
 EN 14411:2016 GROUP \_GRUPO \_GROUPE \_GRUPPE BIII



NEO LINES MIX CARAMEL  
GM 0725



NEO POWDER DECOR 15X15\*  
GM 0788

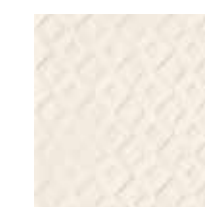

NEO SAND DECOR 15X15\*  
GM 0789



NEO LINES MIX GRUN BLAU  
GM 0726



NEO ASH DECOR 15X15\*  
GM 0790

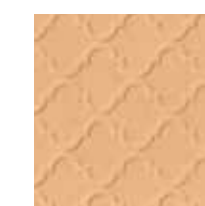

NEO CARAMEL DECOR 15X15\*  
GM 0791



NEO LINES MIX BEGE  
GM 0727



NEO GREEN DECOR 15X15\*  
GM 0792



NEO BLUE DECOR 15X15\*  
GM 0793



NEO LINES MIX GREY  
GM 0728



MOSAICO ESCAMAS\*  
13X14

\*PECAS EMBALADAS ALEATORIAMENTE POR CAIXA  
 TILES ARE PACKED RANDOMLY IN THE SAME BOX

SURFACE _SUPERFÍCIE	FINISH _ACABAMENTO	SIZES _FORMATOS	THICKNESS _ESPESSURA
MATT	NATURAL (NAT) RECTIFIED (R)	30X90 R	10,5 MM
		30X90 NAT	
		30X60 R	9,5 MM
		30X60 NAT	





# STEEL

 **WHITE BODY WALL TILES** \_REVESTIMENTOS EM PASTA BRANCA \_CARREAUX DE MUR EN PATE BLANCHE  
WEISSEN TON WANDFLIESEN \_REVESTIMIENTOS EN PASTA BLANCA  
EN 14411:2016 GROUP \_GRUPO \_GROUPE \_GRUPPE BIII



STEEL WHITE  
GM 0769



STEEL COMB WHITE  
GM 0785



STEEL FOG  
GM 0770



STEEL COMB FOG  
GM 0786



STEEL SMOKE  
GM 0771



STEEL COMB SMOKE  
GM 0787

STEEL WHITE 25X70 R  
STEEL FOG 25X70 R  
RUSTY DECOR 60X60

**SURFACE** \_SUPERFÍCIE

MATT

**FINISH** \_ACABAMENTO

NATURAL (NAT)  
RECTIFIED (R)

**SIZES** \_FORMATOS

**THICKNESS** \_ESPESSURA

25X70 R  
25X70 NAT

10 MM



# PLASTER

 **WHITE BODY WALL TILES** \_REVESTIMENTOS EM PASTA BRANCA \_CARREAUX DE MUR EN PATE BLANCHE  
WEISSEN TON WANDFLIESEN \_REVESTIMIENTOS EN PASTA BLANCA  
EN 14411:2016 GROUP \_GRUPO \_GROUPE \_GRUPPE BIII

**SURFACE** \_SUPERFÍCIE

MATT

**FINISH** \_ACABAMENTO

NATURAL (NAT)  
RECTIFIED (R)

**SIZES** \_FORMATOS  
**THICKNESS** \_ESPESSURA

25X70 R                      10 MM  
25X70 NAT



PLASTER WHITE  
GM 0772



PLASTER WAVE WHITE  
GM 0774



PLASTER GREY  
GM 0773



PLASTER WAVE GREY  
GM 0775



PLASTER WAVE GREY 25X70 R



# BROOKLYN

 **WHITE BODY WALL TILES** \_REVESTIMENTOS EM PASTA BRANCA \_CARREAUX DE MUR EN PATE BLANCHE  
WEISSEN TON WANDFLIESEN \_REVESTIMIENTOS EN PASTA BLANCA  
EN 14411:2016 GROUP \_GRUPO \_GROUPE \_GRUPPE BIII

**SURFACE** \_SUPERFÍCIE

MATT

**FINISH** \_ACABAMENTO

NATURAL (NAT)  
RECTIFIED (R)

**SIZES** \_FORMATOS  
**THICKNESS** \_ESPESSURA

30X60 R 9,5 MM  
30X60 NAT



BROOKLYN WHITE  
GM 0707



BROOKLYN ASH  
GM 0708



BROOKLYN FOG  
GM 0709



BROOKLYN SMOKE  
GM 0710



BROOKLYN LIGHT  
GM 0711

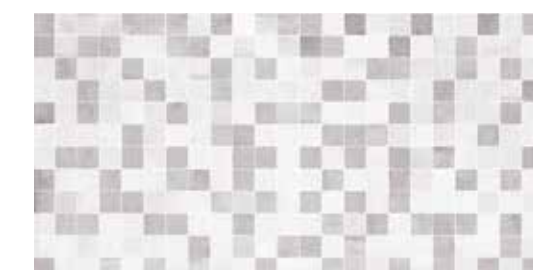

BROOKLYN DARK  
GM 0712



BROOKLYN DECOR  
GM 0713



BROOKLYN FOG 30X60  
HERITAGE COLOR 4



# OXYDA

 **WHITE BODY WALL TILES** \_REVESTIMENTOS EM PASTA BRANCA \_CARREAUX DE MUR EN PATE BLANCHE  
WEISSEN TON WANDFLIESEN \_REVESTIMIENTOS EN PASTA BLANCA  
EN 14411:2016 GROUP \_GRUPO \_GROUPE \_GRUPPE BIII

**SURFACE** \_SUPERFÍCIE

**GLOSSY**

**FINISH** \_ACABAMENTO

**NATURAL (NAT)**  
**RECTIFIED (R)**

**SIZES** \_FORMATOS  
**THICKNESS** \_ESPESSURA

**30X60 R** 9,5 MM  
**30X60 NAT**



OXYDA WHITE  
GM 0731



OXYDA WHITE SQUARES  
GM 0735



OXYDA OFFWHITE  
GM 0732



OXYDA OFFWHITE SQUARES  
GM 0736



OXYDA RUST  
GM 0733



OXYDA RUST SQUARES  
GM 0737



OXYDA TITAN  
GM 0734



OXYDA TITAN SQUARES  
GM 0738



OXYDA WHITE 30X60 R



# BURLINGTON

 **WHITE BODY WALL TILES** \_REVESTIMENTOS EM PASTA BRANCA \_CARREAUX DE MUR EN PATE BLANCHE  
WEISSEN TON WANDFLIESEN \_REVESTIMIENTOS EN PASTA BLANCA  
EN 14411:2016 GROUP \_GRUPO \_GROUPE \_GRUPPE BIII



BURLINGTON FOG  
GM 0739



BURLINGTON FOG SQUARES  
GM 0742



BURLINGTON CREAM  
GM 0740



BURLINGTON CREAM SQUARES  
GM 0743



BURLINGTON TAUPE  
GM 0741



BURLINGTON TAUPE SQUARES  
GM 0744

**SURFACE** \_SUPERFÍCIE

MATT

**FINISH** \_ACABAMENTO

NATURAL (NAT)  
RECTIFIED (R)

**SIZES** \_FORMATOS

**THICKNESS** \_ESPESSURA

30X60 R 9,5 MM  
30X60 NAT



BURLINGTON FOG 30X60  
BURLINGTON SQUARES FOG 30X60



# LUXOR

 **WHITE BODY WALL TILES** \_REVESTIMENTOS EM PASTA BRANCA \_CARREAUX DE MUR EN PATE BLANCHE  
WEISSEN TON WANDFLIESEN \_REVESTIMIENTOS EN PASTA BLANCA  
EN 14411:2016 GROUP \_GRUPO \_GROUPE \_GRUPPE BIII

**SURFACE** \_SUPERFÍCIE

GLOSSY

**FINISH** \_ACABAMENTO

NATURAL (NAT)

**SIZES** \_FORMATOS

**THICKNESS** \_ESPESSURA

30X60 NAT 9,5 MM

33X33 NAT 7,8 MM



LUXOR GREY  
GM 0511



LUXOR GREY DECOR  
GM 0513

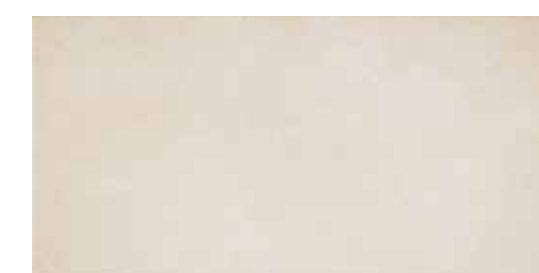

LUXOR BEGE  
GM 0512



LUXOR BEGE DECOR  
GM 0519



LUXOR BEGE 30X60  
LUXOR BEGE DECOR 30X60  
LUXOR BEGE 33X33



# BRANCOS

 **WHITE BODY WALL TILES** \_REVESTIMENTOS EM PASTA BRANCA \_CARREAUX DE MUR EN PATE BLANCHE  
WEISSEN TON WANDFLIESEN \_REVESTIMIENTOS EN PASTA BLANCA  
EN 14411:2016 GROUP \_GRUPO \_GROUPE \_GRUPPE BIII

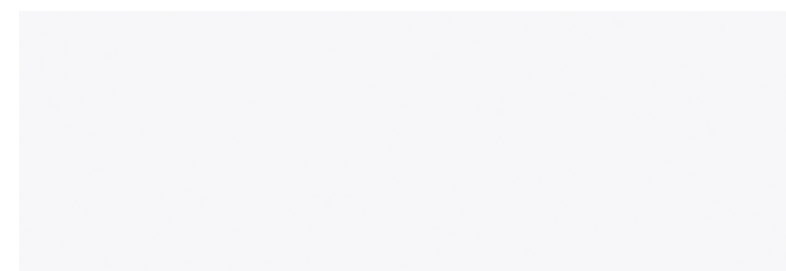

BRANCO BRILHO  
GM 0001

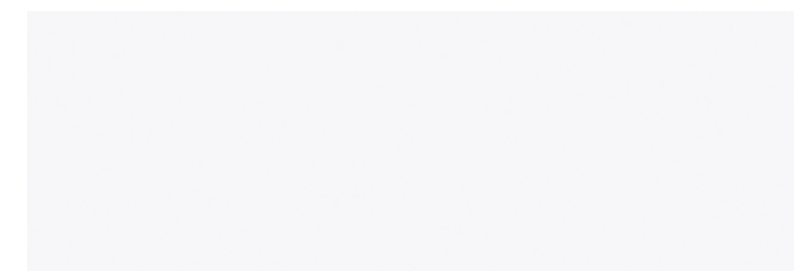

BRANCO MATE  
GM 0002

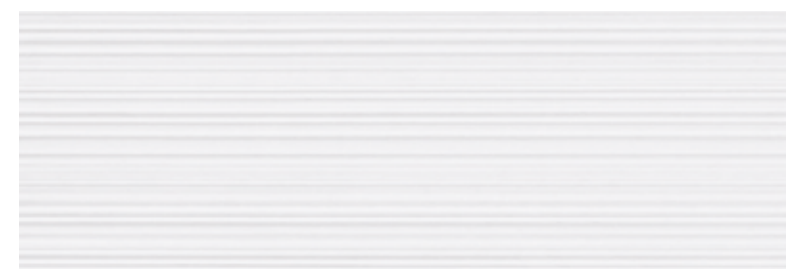

BRANCO BRILHO LINES  
GM 0783

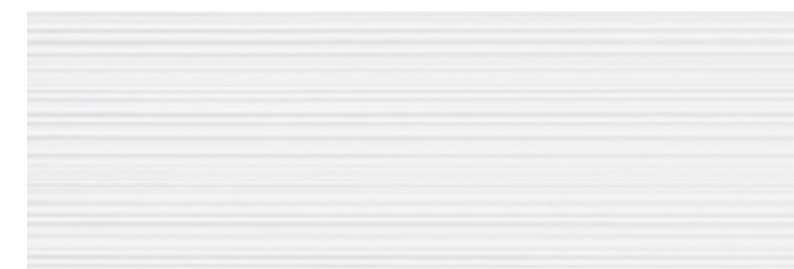

BRANCO MATES LINES  
GM 0784



BRANCO BRILHO SQUARES  
GM 0781



BRANCO MATE SQUARES  
GM 0782



BRANCO BRILHO 30X60

SURFACE _SUPERFÍCIE	FINISH _ACABAMENTO	SIZES _FORMATOS	
		THICKNESS _ESPESSURA	
MATT GLOSSY	NATURAL (NAT)	30X90 R	10,5 MM
	RECTIFIED (R)	25X70 R	10 MM
		25X70 NAT	
		30X60 R	9,5 MM
		30X60 NAT	
		20X50 NAT	9 MM



**PLAYTTILE**  
**20X50**





+ +  
+

*new tastes*  
NEW COLORS





















*color  
the  
way*



**PLAYTILE**







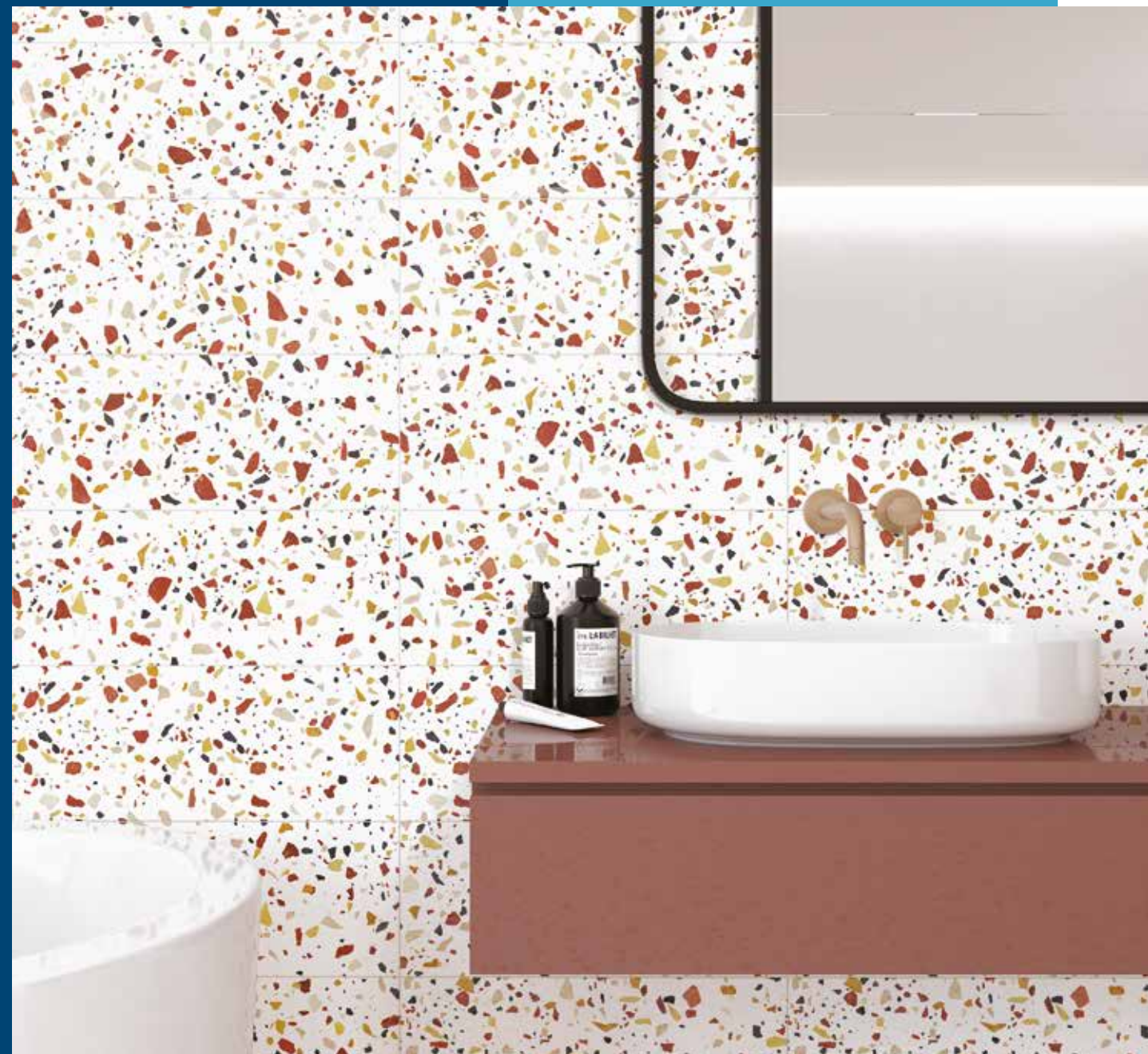





PLAYTILE AMARELO BRILHO  
GM 0169



PLAYTILE AZUL CLARO BRILHO  
GM 0170



PLAYTILE AZUL ESCURO BRILHO  
GM 0171



PLAYTILE LARANJA BRILHO  
GM 0172



PLAYTILE VERDE BRILHO  
GM 0173



PLAYTILE ROSA BRILHO  
GM 0174



PLAYTILE VIOLETA BRILHO  
GM 0280



PLAYTILE VERMELHO BRILHO  
GM 0176



GA 1470



GA 1471



GA 1472



GA 1473



GA 1474

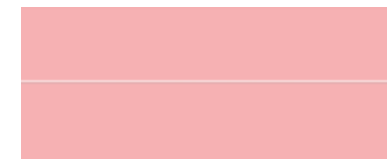

GA 1475



GA 1792



GA 1477

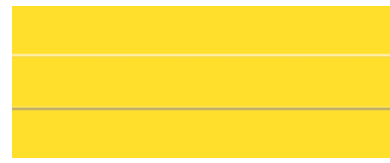

GA 1487



GA 1488



GA 1489



GA 1490



GA 1491



GA 1492



GA 1793



GA 1494

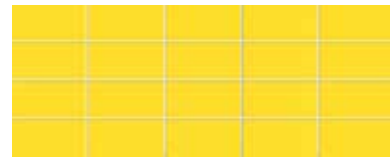

GA 1504

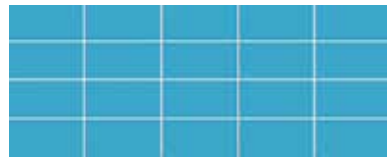

GA 1505

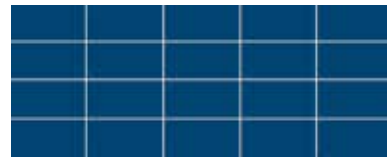

GA 1506

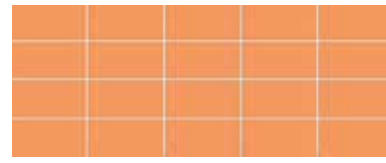

GA 1507

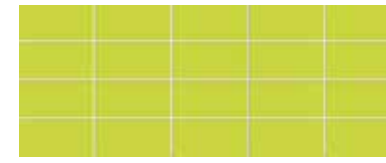

GA 1508

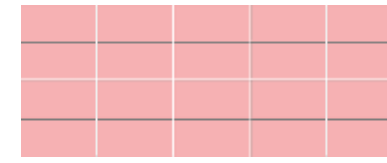

GA 1509

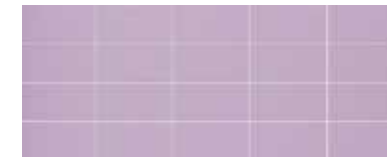

GA 1794



GA 1511

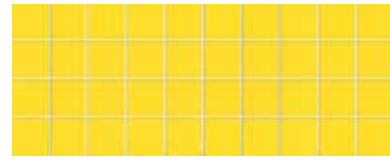

GA 1521



GA 1522

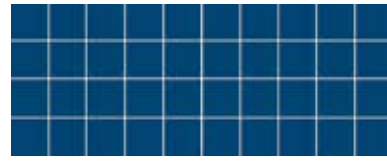

GA 1523

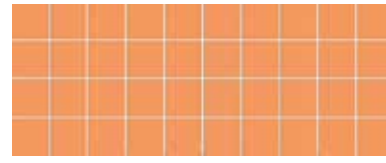

GA 1524

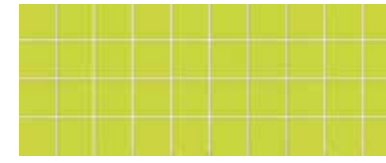

GA 1525

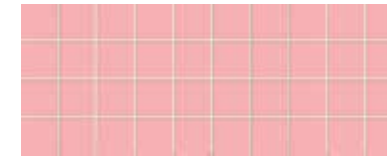

GA 1526



GA 1795



GA 1528



GA 2224



GA 2225



GA 2226



GA 2227



GA 2228



GA 2229



GA 2237



GA 2231



GA 1402



GA 1403



GA 1404



GA 1405



GA 1406



GA 1407



GA 1786



GA 1409



GA 1453



GA 1454



GA 1455



GA 1456



GA 1457



GA 1458



GA 1788



GA 1460



GA 1777  
2X50



GA 1778  
2X50



GA 1779  
2X50



GA 1780  
2X50



GA 1781  
2X50



GA 1782  
2X50













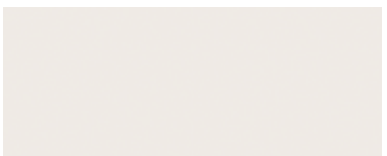

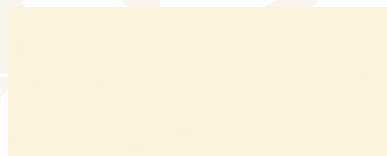





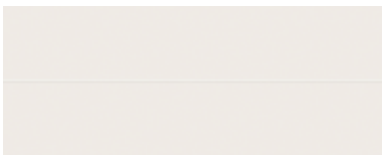
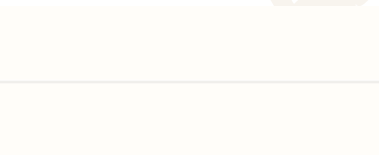
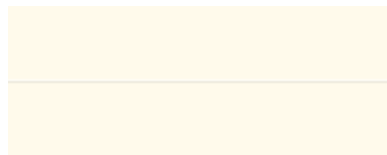
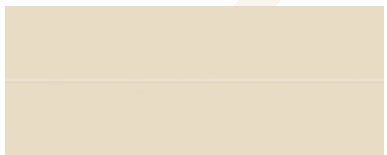



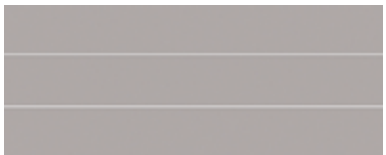
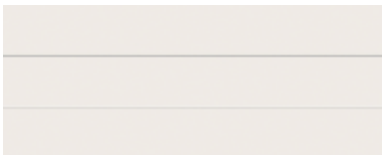
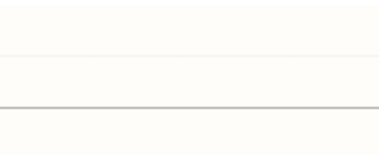
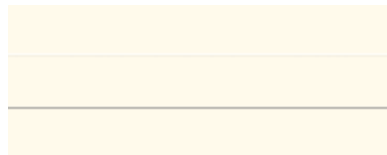
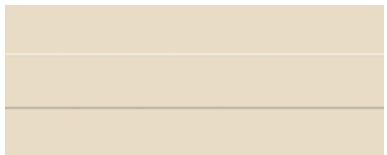
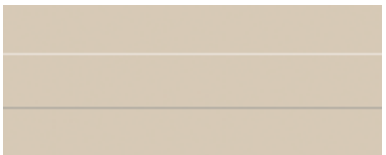
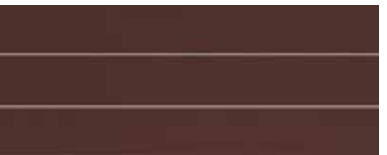
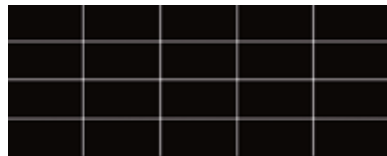
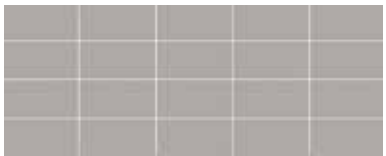
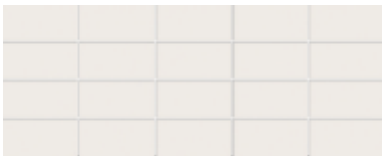
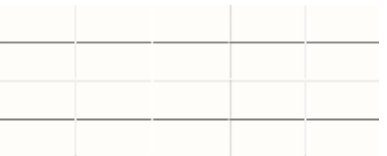
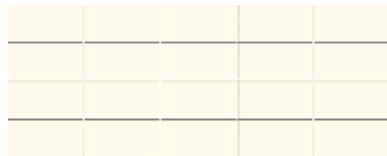
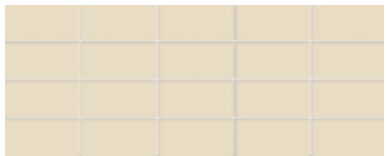
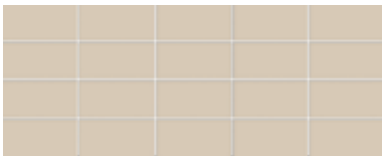
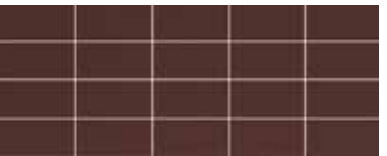
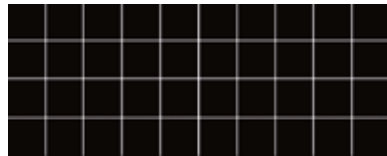
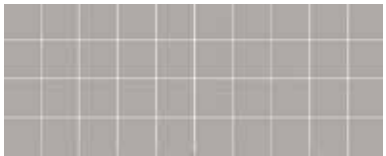

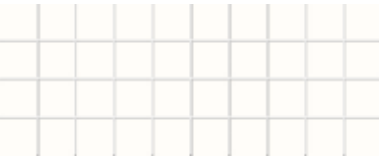



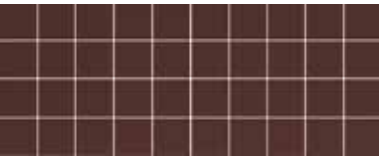

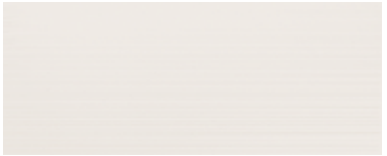
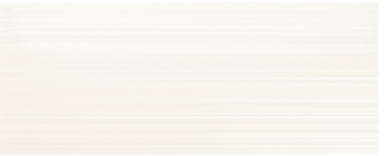















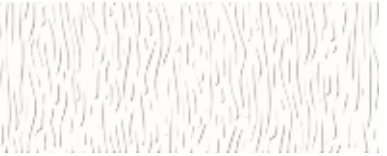



GA 1785  
2X50

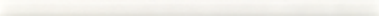
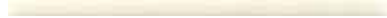

GA 1784  
2X50



 PLAYTILE PRETO BRILHO GM 0175	 PLAYTILE CINZA BRILHO GM 0410	 PLAYTILE CINZA CLARO BRILHO GM 0633	 PLAYTILE BRANCO BRILHO GM 0001	 PLAYTILE OFF-WHITE BRILHO GM 0165	 PLAYTILE CREME BRILHO GM 0408	 PLAYTILE TERRA BRILHO GM 0409	 PLAYTILE CASTANHO BRILHO GM 0412
 GA 1476	 GA 2193	 GA 2299	 GA 1468	 GA 1469	 GA 2185	 GA 2189	 GA 2201
 GA 1493	 GA 2194	 GA 2300	 GA 1485	 GA 1486	 GA 2186	 GA 2190	 GA 2202
 GA 1510	 GA 2195	 GA 2301	 GA 1502	 GA 1503	 GA 2187	 GA 2191	 GA 2203
 GA 1527	 GA 2196	 GA 2302	 GA 1519	 GA 1520	 GA 2188	 GA 2192	 GA 2204
 GA 2230	 GA 2141	 GA 2311	 GA 2220	 GA 2222	 GA 2239	 GA 2240	 GA 2243
 GA 1408	 GA 2212	 GA 2307	 GA 1400	 GA 1401	 GA 2210	 GA 2211	 GA 2214
 GA 1459	 GA 2217	 GA 2309	 GA 1451	 GA 1452	 GA 2215	 GA 2216	 GA 2219
 GA 1783 2X50	 GA 2207 2X50	 GA 2313 2X50	 GA 1775 2X50	 GA 1776 2X50	 GA 2205 2X50	 GA 2206 2X50	 GA 2209 2X50

glossy

PLAYTILE BRILHO





PLAYTILE PRETO MATE  
GM 0281



PLAYTILE CINZA MATE  
GM 0181

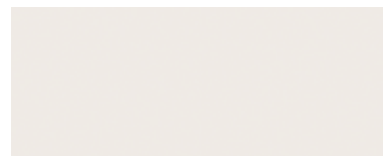

PLAYTILE CINZA CLARO MATE  
GM 0634



PLAYTILE BRANCO MATE  
GM 0002

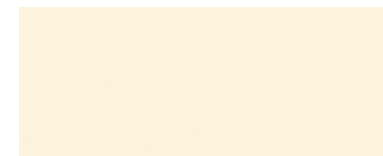

PLAYTILE OFF-WHITE MATE  
GM 0166



PLAYTILE CREME MATE  
GM 0179



PLAYTILE TERRA MATE  
GM 0180



PLAYTILE CASTANHO MATE  
GM 0183



GA 1796



GA 1482

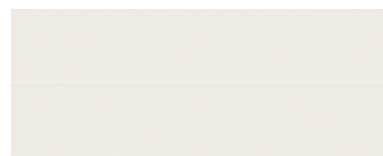

GA 2303

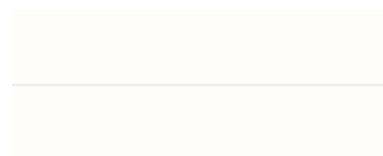

GA 1478

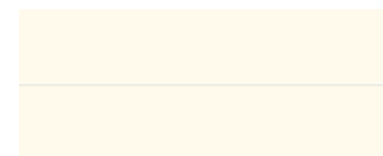

GA 1479

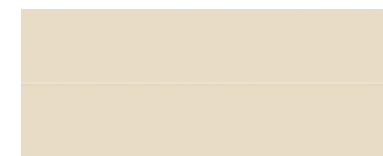

GA 1480



GA 1481



GA 1484



GA 1797

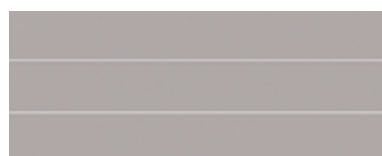

GA 1499

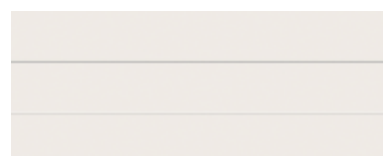

GA 2304

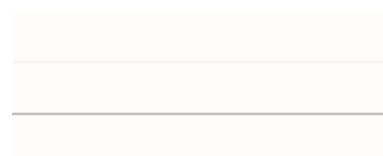

GA 1495

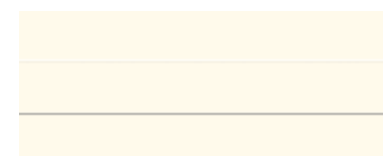

GA 1496

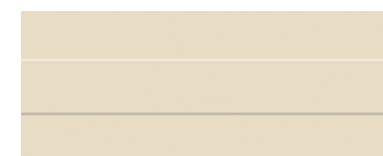

GA 1497

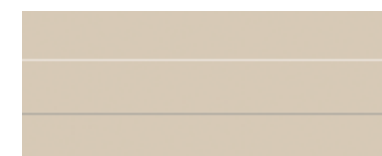

GA 1498

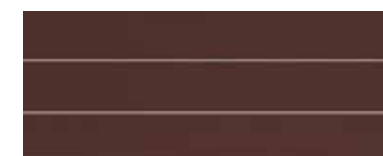

GA 1501

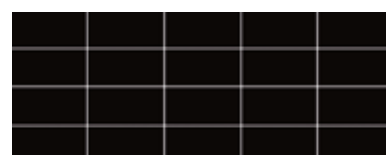

GA 1798

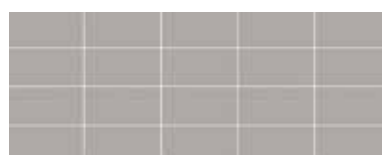

GA 1516

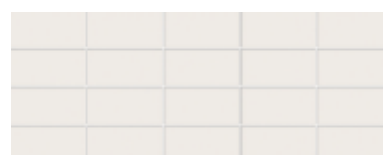

GA 2305

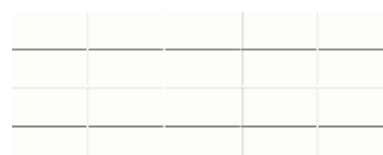

GA 1512

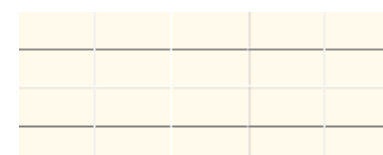

GA 1513

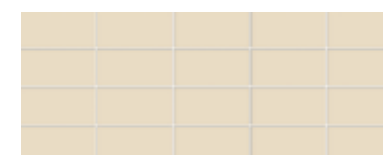

GA 1514

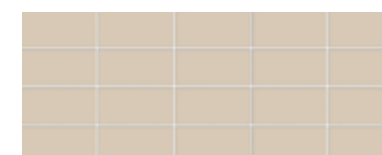

GA 1515

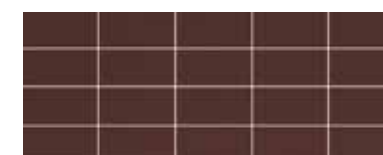

GA 1518

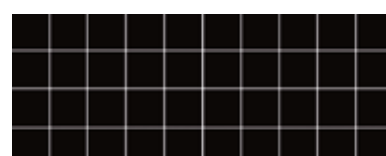

GA 1799

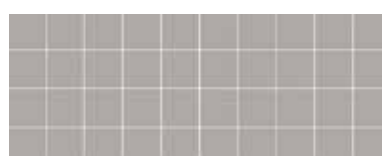

GA 1533



GA 2306



GA 1529



GA 1530

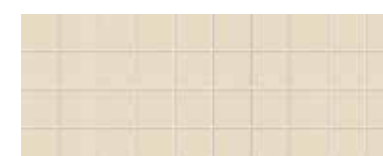

GA 1531

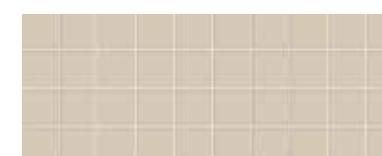

GA 1532

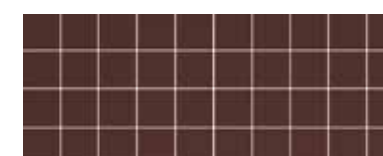

GA 1535



GA 2238



GA 2234



GA 2312



GA 2221



GA 2223



GA 2232



GA 2233



GA 2236



GA 1789



GA 1414

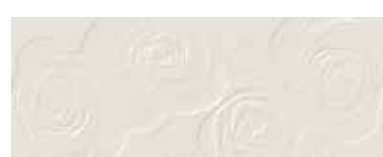

GA 2308



GA 1410



GA 1411



GA 1412



GA 1413



GA 1416



GA 1791



GA 1465

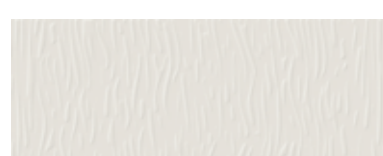

GA 210



GA 1461



GA 1462



GA 1463



GA 1464



GA 1467

mate

PLAYTILE MATE





PLAYTILE DECOR BLUE  
GM 0651



PLAYTILE DECOR COLOR  
GM 0652



# new DECORS 20X50

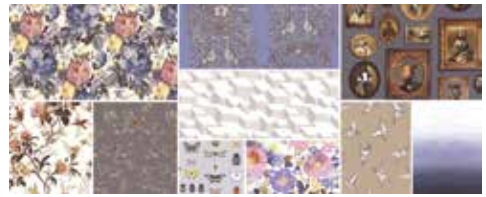
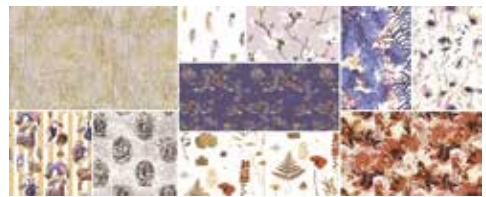

PLAYTILE DECOR PATCHWORK  
GM 0653



PLAYTILE DECOR MUSIC  
GM 0635



PLAYTILE DECOR SOAP  
GM 0636



PLAYTILE DECOR ANGELS  
GM 0637



PLAYTILE STRACCIATILE BLUE GREEN  
GM 0776



PLAYTILE STRACCIATILE BORDEAUX  
GM 0777



PLAYTILE STRACCIATILE MIMO  
GM 0778



PLAYTILE KIDS SOFT  
GM 0780



PLAYTILE KIDS SOFT  
GM 0780





# PLAYTILE

## MATCHING FLOOR

33X33 / 13"X13"

▼  
10,5 MM  
▲

FLOOR PRETO BRILHO  
GR 0275  
33X33

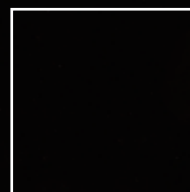

FLOOR BRANCO BRILHO  
GR 0273  
33X33



FLOOR AZUL BRILHO  
GR 0274  
33X33



FLOOR VERMELHO BRILHO  
GR 0276  
33X33



MATRIX BEGE  
GP 0475  
33X33



MATRIX NOZ  
GP 0479  
33X33



MATRIX PISTACHIO  
GP 0477  
33X33



MATRIX CINZA  
GP 0476  
33X33



MATRIX ESTANHO  
GP 0478  
33X33







CODE AZUL 20X50  
CODE BRANCO 20X50





CODE BRANCO 20X50  
CODE VIOLETA 20X50



CODE BEGE 20X50



CODE BRANCO  
GM 0385  
20X50



CODE BEGE  
GM 0386  
20X50



CODE CINZA  
GM 0387  
20X50



CODE AZUL  
GM 0388  
20X50

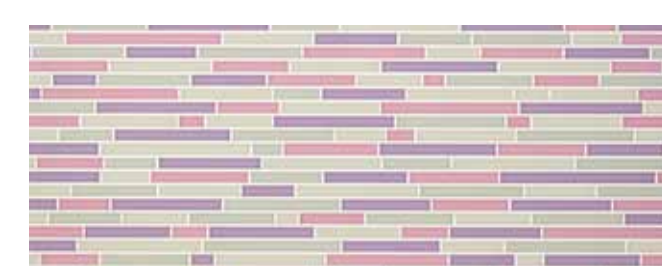

CODE VIOLETA  
GM 0389  
20X50



**EMBALAGENS E PESOS • PACKING LIST**

GRÉS PORCELÂNICO • GLAZED PORCELAIN								
	ACABAMENTO FINISH	FORMATO SIZE	PEÇAS CAIXA PIECES BOX	PESO CAIXA WEIGHT BOX	M2 CAIXA SQ.MT.BOX	CAIXAS PALETTE BOX PALLET	PESO PALETTE WEIGHT PALLET	M2 PALETTE SQ.MT.PALLET
GP	NAT	60x60 / 24"x24"	4	± 26.5 Kg	1,47	32	± 848 Kg	47,04
GP	NAT	60x60 / 24"x24"	3	± 26.5 Kg	1,10	32	± 848 Kg	35,20
GP	NAT	50x50 / 20"x20"	4	± 22 Kg	1,02	36	± 792 Kg	36,72
GP	NAT	22,5x90 / 9"x36"	6	± 23 Kg	1,22	48	± 1.104 Kg	58,56
GP	NAT	30x60 / 12"x24"	7	± 24 Kg	1,27	40	± 960 Kg	50,80
GP	NAT	30x60 / 12"x24"	7	± 24 Kg	1,27	60	± 1.440 Kg	76,20
GP	NAT	40x40 / 16"x16"	9	± 25 Kg	1,46	48	± 1.200 Kg	70,08
GP	NAT	33x47 / 13"x18"	7	± 21 Kg	1,10	44	± 924 Kg	48,40
GP	NAT	33x33 / 13"x13"	10	± 17 Kg	1,15	68	± 1.156 Kg	78,20
GP	NAT	15x75 / 6"x30"	10	± 21.5 Kg	1,13	60	± 1.290 Kg	67,80
GP	NAT	15x60 / 6"x24"	12	± 23.5 Kg	1,08	40	± 940 Kg	43,20

Indica-se a utilização de junta mínima de 3 mm para produtos NAT. • For NAT products, use a minimum 3 mm joint.

GRÉS PORCELÂNICO RETIFICADO / SEMI-POLIDO • GLAZED PORCELAIN RECTIFIED / SEMI-POLISHED								
GPR	R / SP	90x90 R / 36"x36"	2	± 35 Kg	1,61	36	± 1.260 Kg	57,96
GPR	R / SP	60x120 R / 24"x48"	2	± 35 Kg	1,43	29	± 1.015 Kg	41,47
GPR	R / SP	45x90 R / 18"x36"	4	± 35 Kg	1,61	42	± 1.470 Kg	67,62
GPR	R / SP	60x60 R / 24"x24"	4	± 26.5 Kg	1,43	32	± 848 Kg	45,76
GPR	R / SP	60x60 R / 24"x24"	3	± 26.5 Kg	1,07	40	± 1.060 Kg	42,80
GPR	R / SP	20x120 R / 8"x48"	6	± 35 Kg	1,42	36	± 1.260 Kg	51,12
GPR	R / SP	22,5 x90 R / 9"x36"	6	± 23 Kg	1,17	36	± 828 Kg	42,12
GPR	R / SP	30x60 R / 12"x24"	7	± 24 Kg	1,25	40	± 960 Kg	50
GPR	R / SP	15x75 R / 6"x30"	10	± 21.5 Kg	1,15	60	± 1.290 Kg	69

Indica-se a utilização de junta de 2 mm para produtos R/SP. • For R/SP use a 2mm joint.

REVESTIMENTO EM PASTA BRANCA • WHITE BODY WALL TILES								
GM	NAT	20x50 / 8"x20"	12	± 18 Kg	1,2	48	± 864 Kg	57,60
GM	NAT	30x60 / 12"x24"	7	± 21 Kg	1,26	32	± 672 Kg	40,32
GM	NAT	25x70 / 10"x28"	6	± 19 Kg	1,05	48	± 912 Kg	50,40
GM	NAT	30x90 / 12"x36"	4	± 21 Kg	1,1	42	± 882 Kg	46,20

Indica-se a utilização de junta mínima de 3 mm para produtos NAT. • For NAT products, use a minimum 3 mm joint.

REVESTIMENTO EM PASTA BRANCA RETIFICADA • RECTIFIED WHITE BODY WALL TILES								
GMR	R	30x60 R / 12"x24"	7	± 21 Kg	1,23	32	± 672 Kg	39,36
GMR	R	25x70 R / 10"x28"	6	± 19 Kg	0,97	48	± 912 Kg	46,56
GMR	R	30x90 R / 12"x36"	4	± 21 Kg	1,05	42	± 882 Kg	44,10

Indica-se a utilização de junta de 2 mm para produtos R. • For R use a 2mm joint.

Os valores das dimensões e pesos são aproximados.  
O peso de uma paleta é aproximadamente 20 kg.  
O peso da paleta não está incluído nos valores indicados nos quadros.

Size and weight values are approximate  
The weight of one pallet is approximate 20 kg.  
The pallet weight is not include in the values mentioned in the table.

**FORMATOS DISPONÍVEIS • AVAILABLE FORMATS\_(NOMINAL SIZES\_FORMATOS NOMINAIS)**

**PORCELAIN**

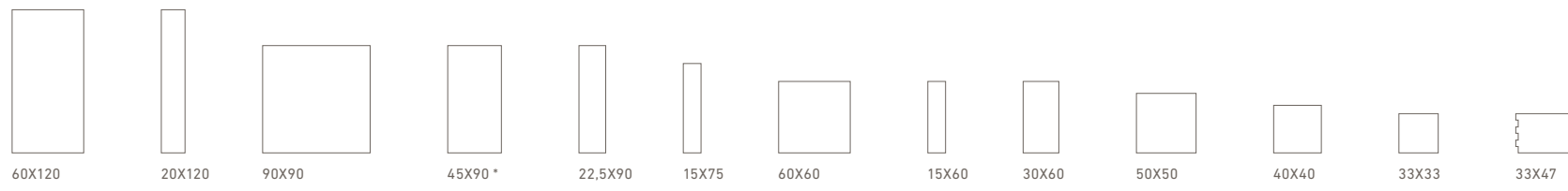

ANARCHIC BEDROCK BETON GAME OF STONES LIVING METALLICA SASSI TERRAZZO	DECK OAK PAINTWOOD SHABBY VERMONT	ANARCHIC BEDROCK BETON LIVING METALLICA SASSI TERRAZZO	ANARCHIC BEDROCK BETON LIVING METALLICA SASSI TERRAZZO	OAK SHABBY VERMONT	DECK MAPLE OAK PAINTWOOD	ANARCHIC BEDROCK BETON CEMENTONE GAME OF STONES LIVING MATRIX METALLICA MIX&MATCH MOLEANOS RUSTY SANDSTONE SASSI TERRAZZO URBAN CONCRETE	DECK VINTAGE	ANARCHIC ARDÓSIA BEDROCK BETON CEMENTONE DECK FORM GAME OF STONES LIVING MATRIX METALLICA MIX&MATCH MOLEANOS RORIZ RUSTY SANDSTONE SASSI SLATE TERRAZZO URBAN CONCRETE	AVANT	BETON HERITAGE	ARDÓSIA COTTO FLOOR LUXOR MATRIX RORIZ	BRICK LINEA
---	---	--	--	--------------------------	-----------------------------------	--	-----------------	---	-------	-------------------	---	----------------

**WALL**



BRANCOS PLASTER STEEL	BRANCOS BROOKLYN BURLINGTON GAME OF STONES LUXOR METALLICA MIX&MATCH NEO OXYDA	BRANCOS GAME OF STONES METALLICA NEO	BRANCOS CODE PLAYTILE
-----------------------------	--	---	-----------------------------

\* Sob encomenda / By special order

**RESISTÊNCIA À ABRASÃO • ABRASION RESISTANCE • RÉSISTANCE À LÁBRASION • ABRIEFESTIGKEIT**

PEI 1
Pavimentos sujeitos a tráfego ligeiro, aplicados em ambientes protegidos de agentes abrasivos e cortantes, tipo areias e gravilhas. Aplicações: Quarto de dormir e banhos privados. Floors subject to light traffic and protected from abrasive and scratching agents such as sand, gravel, etc. These floor tiles may be used in bedrooms or bathrooms of private dwellings.
PEI 2
Pavimentos sujeitos a tráfego médio/leve em ambientes protegidos de agentes abrasivos e cortantes, tipo areias e gravilhas. Aplicações: todas as divisões de habitação particular, excepto em cozinhas e corredores. Floors exposed to medium-light traffic and protected from abrasive and scratching agents such as sand, gravel, etc. In general, these floor tiles may be used in private houses, except kitchens and halls.
PEI 3
Pavimentos sujeitos a tráfego médio, aplicados em ambientes protegidos de agentes abrasivos e cortantes, tipo areias e gravilhas. Aplicações: todas as divisões de habitações particulares, incluindo a cozinha, suites de hotéis, quartos de hospital, etc. Floors exposed to medium traffic and protected from abrasive and scratching agents such as sand, gravel, etc. These floor tiles are ideal for any part of the house, including the kitchen, hotel-rooms with relative facilities, hospital-rooms, etc.
PEI 4
Pavimentos sujeitos a tráfego médio/intenso, podendo ser aplicados em ambientes com acesso directo ao exterior. Aplicações: terraços, restaurantes, hotéis, escritórios, hospitais, etc. Floors exposed to medium-heavy traffic and not protected from abrasive and scratching agents such as sand, gravel, or have direct access to the outdoor. These floor tiles are ideal for terraces and public spaces with a medium-level use, such as restaurants, hotels, offices, hospitals, etc.
PEI 5
Pavimentos sujeitos a tráfego intenso, colocados em ambientes não protegidos de agentes abrasivos e cortantes, tipo areias e gravilhas e com acesso ao exterior. Aplicações: Locais públicos, como bares, restaurantes, hotéis, lojas, escolas, escritórios, hospitais, etc. Floors exposed to heavy traffic in rooms which are subject to abrasive and scratching agents such as sand or gravel, or have direct access to the exterior. These floor tiles are ideal for public places such as restaurants, hotels, shops, schools, offices, hospitals, etc.

**FORMAS DE APLICAÇÃO • TILING INSTRUCTIONS • FAÇONS DES POSE • VERLEFUNGARTEN**

Aplicação em contra fiada não recomendada a mais de 1/3 da peça.  
It's not recommended laying the pieces more than 1/3 of the length of the tile.  
Pose conseillée avec un décalage entre chaque carreau non supérieur à 1/3 de la longueur du carreau même.  
Bei einer versetzten Verlegung empfehlen wir 1/3 (zweidrittel) Verbandverlegung.

Correcto / Correct

1/3 Peça • Piece • Carreaux

Incorrecto / Incorrect

1/2 Peça • Piece • Carreaux

Quando se trata de produtos com relevo nas suas peças (p.ex Coleção DECK), a aplicação das peças na mesma direcção podem apresentar um ligeiro desalinhamento intrínseco ao produto. Recomenda-se a utilização de junta aproximadamente, 3 mm.

When applying pieces in the same direction, the slight deviation of the flat part and/or stripes (eg. DECK collection) is a characteristic intrinsic to the product. We recommend the use of joint of approximately 3mm.

Lors de la pose de carreaux structurés dans le même sens (par ex. la collection DECK), un léger décalage de l'alignement de la partie lisse et/ou rayures est une caractéristique intrinsèque du produit. Nous recommandons l'utilisation d'un joint d'environ 3mm.

Wenn es sich um Produkte mit Prägung handelt (z.B. DECK Kollektion), kann die Verlegung der Fliesen in die selbe Richtung eine eigene optische Verlagerung präsentieren. Hier wird eine Fuge von etwa 3mm empfohlen.

**VARIAÇÕES DE TONALIDADE • VARIATION IN TONE • VARIATIONS DE TONALITÉ • FARBABWEICHUNGENN**

UNIFORME • UNIFORM	SUAVE • SOFT • LÉGER • LEICHT	ELEVADA • HIGH • ÉLEVÉE • STARK	ALEATÓRIA • RANDOM • ALÉATOIRE • WILLKÜRLICH
Produto sem destonificação. As diferenças entre peças são mínimas.	As diferenças entre peças são visíveis, dentro de cores similares.	As diferenças entre peças são acentuadas. Quer a cor quer o desenho, podem variar significativamente.	As diferenças entre peças são muito acentuadas. As peças podem apresentar cores totalmente diferentes umas das outras.
Product without tone changes. Differences between tiles are minimum.	Differences between tiles are noticeable, within the same range of colour.	As diferenças entre peças são acentuadas. Quer a cor quer o desenho, podem variar significativamente.	Differences between tiles are very clear. Tiles can present completely different colours from one to the other.
Produit sans détonification. Les différences entre les pièces sont minimales.	Les différences entre les pièces sont visibles, dans des couleurs semblables.	Les différences entre les pièces sont accentuées. Aussi bien la couleur comme le dessin, peuvent varier de façon assez importante.	Les différences entre les pièces sont très accentuées. Les pièces peuvent présenter des couleurs totalement différentes les unes des autres.
Produkt ohne Farbabweichungen. Die Unterschiede sind minimal.	Die Unterschiede zwischen de Fliesen sind erkennbar innerhalb der Farbpalette.	Die Unterschiede zwischen den Fliesen sind beachtlich, sowohl die Farbe als auch das Design können deutlich variieren.	Die Unterschiede zwischen den Fliesen sind sehr deutlich. Die Fliesen können unter sich verschiedene Farben aufweisen.



## LIMPEZA E MANUTENÇÃO

Após a aplicação dos mosaicos e respectiva junta é e extrema importância efectuar as operações de limpeza de obra, de forma a eliminar os resíduos de aplicação (cimentos, colas, massa de juntas, tintas) bem como possíveis resíduos superficiais do material. Recomenda-se que, imediatamente após a junta secar, se limpe os excessos destes produtos com um pano humedecido (Segundo sempre as indicações do fabricante).

A maioria dos problemas manifestados após a obra deve-se a uma má e por vezes inexistente limpeza após a aplicação, consultar a tabela:

TIPO DE SUJIDADE INCRUSTADA	PRODUTO FILA RECOMENDADO *
Resíduos de cimento, resíduos calcários, resíduos óxidos, ferrugem.	DETERDEK PRO
Resíduos de junta epoxi ou resinosa.	FILACR10
Sujidade normal / diária ligeira.	FILACLEANER PRO
Sujidade intensa (comida, óleo, azeite, café, graxa), resíduos de detergentes e sabão, borracha/pneus, tintas, etc.	FILAPS87 PRO
<b>Atenção:</b> Respeitar as precauções de utilização e diluição aconselhadas pelo produtor dos detergentes. Não utilizar produtos que contenham ácido fluorídrico e/ou os seus derivados. * Mais informação: <a href="http://www.filasolutions.com">www.filasolutions.com</a> Para mais informações, por favor consulte as FAQ em <a href="http://www.gresart.pt">www.gresart.pt</a>	

## NETTOYAGE ET ENTRETIEN

Après pose et jointement des carreaux, il est extrêmement important d'effectuer les opérations de nettoyage de fin de chantier afin d'éliminer tous résidus (ciment, joint, colles et Peintures), même superficiels, de la mise en oeuvre. Il est conseillé que, immédiatement après le séchage du joint, que le surplus des produits soient retirés à l'aide d'un torchon humide (en Suivant toujours les indications du fabricant).

La plupart des problèmes qui surgissent après la fin du chantier sont du à un mauvais voir inexistant nettoyage après Plus spécifique voir tableau ci-dessous:

TYPE DE SALETÉ	PRODUIT RECOMMANDÉ PAR FILA *
Dépôts/efflorescences de calcaire, encres, rouille et oxydation, mortier	DETERDEK PRO
Déchet époxy ou joint en résine.	FILACR10
Saleté légère normale / quotidienne	FILACLEANER PRO
Saleté intense (vin , glace et café , thé grasses, caoutchouc de pneus/ peinture , huile de graissage   vernis , cire/ crayon de papier, resines, etc.)	FILAPS87 PRO
<b>Attention:</b> Respectez les précautions d'emploi et de dilution recommandées par le fabricant du détergent. N'utilisez pas de produits contenant de l'acide fluorhydrique et / ou ses dérivés. * Plus d'informations : <a href="http://www.filasolutions.com">www.filasolutions.com</a> Pour plus d'informations, veuillez consulter la section des Questions Fréquentes sur notre site web.	

### NOTAS IMPORTANTES

Todas as imagens apresentadas neste catálogo são meramente ilustrativas, carecendo sempre a confirmação "in loco" das diferenças de tonalidades dos produtos e ambientes. A Gresart, SA, reserva-se o direito de alterar e/ou anular, total ou parcialmente, qualquer um dos formatos, referências e especificações técnicas apresentados neste catálogo.

As especificações técnicas são válidas unicamente para os produtos de 1ª escolha.

As dimensões apresentadas neste catálogo, correspondem a dimensões nominais (aproximadas), pelo que deve confirmar as dimensões exactas na tabela de calibres dos diferentes formatos.

Os pesos apresentados nas tabelas de embalagem e paletização são meramente indicativos.

### IMPORTANT INFORMATION

All images shown in this catalog are for illustrative purposes only.

Gresart, SA reserves the right to change and / or cancel, in whole or in part, any of the formats, references and technical specifications presented in this catalog.

The technical specifications are valid only for 1st choice products.

The dimensions shown in this catalog correspond to nominal (approx.) dimensions, so please confirm the exact dimensions in the caliber table of the different formats.

The weights shown in the packing list are indicative only.

### NOTES IMPORTANTES

Toutes les images figurant dans ce catalogue ne sont qu'illustratives, obligeant toujours à la confirmation "in loco" des différences de tonalité au niveau des carreaux bien comme au niveau des ambiances.

Gresart, SA, se réserve le droit de modifier et/ou supprimer, totalement ou partiellement, quelconque format, référence et spécification technique présentés dans ce catalogue.

Les spécifications techniques ne sont valables que pour les produits de 1er choix.

Les dimensions indiquées dans ce catalogue correspondent aux dimensions nominales (approximatives), c'est pourquoi il faudra confirmer les dimensions exactes dans le tableau des calibres pour les différents formats.

Les poids indiqués dans la liste de colisage bien comme la palettisation sont à titre indicatif.

### WICHTIGE HINWEISE

Alle bilder in diesem katalog sind nur illustrativ, deshalb sollte jeweils eine bestätigung der verschieden tonalitäten der produkte und umgebung vor ort erfolgen.

Gresart, SA, behält sich das recht auf jegliche formate, referenzen oder technische spezifikationen aus diesem katalog ganz- oder teilweise zu ändern und/oder zu widerrufen.

Die technischen spezifikationen gelten nur für 1. Wahl produkte.

Die größenangaben in diesem katalog entsprechen der (ungefähren) nominalgrößen. Aus diesem grund, müssen die exakten größen in der tabelle mit den kalibern des jeweiligen formats bestätigt werden.

Die dargestellten gewichte in der tabelle der verpackung und palettisierung sind nur richtungsweisend.

## CLEANING AND MAINTENANCE

After laying the tiles and grouting it is of outmost importance to perform the final cleaning procedures in order to eliminate any remaining residues (cement, grout , glue, paint) and also any other possible superficial residues. It is recommended that, immediately after the grout dry; the tile fixer should wipe the excess with a wet cloth (always following the manufacturer's instructions).

Most of the noticed problems, once the laying works are complete, are due to inefficient / non existing cleaning Kindly check the chart:

TIPO OF STAIN	PRODUCTS ADVISED BY FILA *
Cement deposits, calcareous matter/deposits, rust and oxides, mortar	DETERDEK PRO
Epoxy or resin deposits.	FILACR10
Normal / daily dirt.	FILACLEANER PRO
Heavy dirt (food, rubber, tire marks, grease, wine, coffee), detergent and soap residues, paints, etc.	FILAPS87 PRO
<b>Attention:</b> Observe the precautions for use and dilution recommended by the detergent manufacturer. Do not use products containing hydrofluoric acid and / or its derivatives. * For more information: <a href="http://www.filasolutions.com">www.filasolutions.com</a> For more information, please check FAQ in <a href="http://www.gresart.pt">www.gresart.pt</a>	









## REINIGUNG UND INSTANDHALTUNG

Nach dem verlegen und ausfugen der fliesen ist es sehr wichtig die reinigungsvorgänge durchzuführen, damit alle rückstände beseitigt werden (mörtel, fugen, klebstoffe, tintenflecke) Sowie eventuelle oberflächliche rückstände. Nachdem die fugen trocken ist, sollen die reste sofort mit einem nassen tuch gereinigt werden (immer die anweisungen vom hersteller folgend).

Die meisten angebrachten problemen nach den arbeiten stammen aus eine schlechte und oft inexistente reinigung nach dem verlegen - für diese reinigung empfehlen wir Kesselsteinlösemittel mit säure; bei der tägliche reinigung empfehlen wir die verwendung von neutral reinigungsmittel und bei der reinigung von spezifische flecken bitte u.A. Anweisungen Sehen:

ART DER VERSCHMUTZUNG	VON FILA EMPFEHLENDE * REINIGUNGSMITTEL
Kalkablagerungen/ablagerungen, tinte, rost und oxydation, mörtel	DETERDEK PRO
Epoxidharz- oder harzdichtung.	FILACR10
Täglicher / normaler schmutz	FILACLEANER PRO
Schwerer schmutz (gummi, harz oder lack, maschinenöl, lack, schmiere, wachsstift, bitumen, wachs, harz, bier/wein, eis und kaffee, etc.)	FILAPS87 PRO
<b>Achtung:</b> Beachten sie die vom waschmittelhersteller empfohlenen vorsichtsmaßnahmen für die anwendung und verdünnung. Verwenden sie keine produkte, die flusssäure und / oder deren derivate enthalten. * Weitere informationen: <a href="http://www.filasolutions.com">www.filasolutions.com</a> Weitere informationen finden Sie auf unserer website.	

## EN 14411

	Características Técnicas Technical Data Caractéristiques Techniques Technische Daten Datos Tecnicos	Norma de Ensaio Test Norm Norme du Test Testnormen Norma de Prueba	Anexo • Annex Annexe • Anhang	G	Anexo • Annex Annexe • Anhang	J	Anexo • Annex Annexe • Anhang	L	
			Grupo • Group Groupe • Gruppe	BIA	Grupo • Group Groupe • Gruppe	BIIA	Grupo • Group Groupe • Gruppe	BIII	G R E S A R T <sup>o</sup> C E R A M I C A
	Comprimento e Largura Length and Width Longueur et Largeur Länge und Breite Longitud y Anchura								Garantido Guaranted Garanti Gewährleistet Garantizado
	Espeçura Thickness Épaisseur Dichte Grosor		± 5 %		± 5 %		± 5 %		Garantido Guaranted Garanti Gewährleistet Garantizado
	Rectilinearidade das Arestas Edge Warpages Rectitude des Arêtes Geradlinigkeit der Kanten Rectitud de los Bordes	EN ISO 10545-2	± 0,5 %		± 0,5 %		± 0,3 %		Garantido Guaranted Garanti Gewährleistet Garantizado
	Medida da Ortogonalidade Rectangularity Angularité Rechtwinkligkeit der Kanten Grado de Ortogonalidad		± 0,5 %		± 0,5 %		± 0,5 %		Garantido Guaranted Garanti Gewährleistet Garantizado
	Medida da Planaridade Surface Flateness Planité de la Superficie Ebenflächigkeit Medición de Planaridad		± 0,5 %		± 0,5 %		± 0,5 %		Garantido Guaranted Garanti Gewährleistet Garantizado
	Absorção de Água Water Absorption Absorption D'eau Wasseraufnahme Absorción de Agua	EN ISO 10545-3	E ≤ 0.5%		3% < E < 6%		E ≥ 10%		Garantido Guaranted Garanti Gewährleistet Garantizado
	Módulo de Rutura Modulus of Rupture Module de Rupture Bruchmodul Módulo de Rutura		≥ 35 N/mm2		≥ 22 N/mm2		≥ 12 N/mm2		Garantido Guaranted Garanti Gewährleistet Garantizado
	Resistência à Flexão Breaking Strength Résistance à la Flexion Biegefestigkeit Resistencia a la Flexión	EN ISO 10545-4							Garantido Guaranted Garanti Gewährleistet Garantizado
	Força de Rutura Breaking Strenght Force de Rupture Bruchfestigkeit Resistencia a la Rotura		≥ 1300 N		≥ 1000 N		≥ 600 N		Garantido Guaranted Garanti Gewährleistet Garantizado
	Resistência à Abrasão Resistance to Abrasion Résistance à Labrasion Abnutzungsbeständigkeit Resistencia a la Abrasion	EN ISO 10545-7			Segundo os Valores do Fabricante According to Manufacter Requirements Selon les Valeurs du Fabricant Gemäss der Werte des Herstellers Según los Valores del Fabricante		Segundo os Valores do Fabricante According to Manufacter Requirements Selon les Valeurs du Fabricant Gemäss der Werte des Herstellers Según los Valores del Fabricante	—	Indicação na Tabela de Preços Indication on Price List Indication sur la Liste de Prix Hinweis auf der Preisliste Indicación en la Tabla de Precios
	Resistência ao Fendilhamento Cracking Resistance Résistance aux Trésaillures Abnutzungsbeständigkeit Resistencia a lo Agrietado	EN ISO 10545-11			Exigido Required Exigée Gefordert Exigido		Exigido Required Exigée Gefordert Exigido	Exigido Required Exigée Gefordert Exigido	Garantido Guaranted Garanti Gewährleistet Garantizado
	Resistência ao Gelo Frost Resistance Résistance au Gel Frostbeständigkeit Resistencia al Hielo	EN ISO 10545-12			Exigido Required Exigée Gefordert Exigido		Exigido Required Exigée Gefordert Exigido	—	Garantido Guaranted Garanti Gewährleistet Garantizado
	Resistência aos Ácidos e Bases Resistance against Acids and Bases Résistance aux Acides et Bases Beständigkeit Gegen Säuren u Laugen Resistencia a los Ácidos y Bases	EN ISO 10545-13			Segundo os Valores do Fabricante According to Manufacter Requirements Selon les Valeurs du Fabricant Gemäss der Werte des Herstellers Según los Valores del Fabricante		Segundo os Valores do Fabricante According to Manufacter Requirements Selon les Valeurs du Fabricant Gemäss der Werte des Herstellers Según los Valores del Fabricante		Mínimo: GLB Minimum: GLB Minimum: GLB Minimum: GLB Minimum: GLB
	Resistência aos Produtos de Limpeza Domesticos Resistance to Household Cleaning Products Résistance aux Produits Ménagers de Nettoyage Beständigkeit Gegen Haushaltsprodukte Resistencia a los Productos de Limpieza Domésticos				Mínimo: GB Minimum: GB Minimum: GB Minimum: GB Minimum: GB		Mínimo: GB Minimum: GB Minimum: GB Minimum: GB Minimum: GB		Garantido Guaranted Garanti Gewährleistet Garantizado
	Resistência às Manchas Staining Resistance Résistance aux Taches Beständigkeit Gegen Flecken Resistencia a las Manchas	EN ISO 10545-14			Mínimo: Classe 3 Minimum: Classe 3 Minimum: Klasse 3 Minimum: Klasse 3		Mínimo: Classe 3 Minimum: Classe 3 Minimum: Klasse 3 Minimum: Klasse 3		Garantido Guaranted Garanti Gewährleistet Garantizado





G R E S A R T® ■  
C E R Â M I C A

GRESART - CERÂMICA INDUSTRIAL S.A.  
APARTADO 39 - EC DE OLIVEIRA DO BAIRRO | 3771-954 OLIVEIRA DO BAIRRO | PORTUGAL  
TEL. +351 234 740 200 | FAX. +351 234 747 462  
GRESART@GRESART.COM | WWW.GRESART.COM





